

**This camera manual library is for reference and historical purposes, all rights reserved.**

**This page is copyright by mike@butkus.org M. Butkus, N.J.**

**This page may not be sold or distributed without the expressed  
permission of the producer**

**I have no connection with any camera company**

**If you find this manual useful, how about a donation of \$3 to: M. Butkus, 29 Lake Ave., High Bridge, NJ 08829-1701 and send your E-mail address too so I can thank you. Most other places would charge you \$7.50 for a electronic copy or \$18.00 for a hard to read Xerox copy. These donations allow me to continue to buy new manuals and maintain these pages. It'll make you feel better, won't it?**

**If you use Pay Pal, use the link below. Use the above address for a check, M.O. or cash. Use the E-mail of butkusmi@ptd.net for PayPal.**



**[back to my "Orphancameras" manuals /flash and light meter site](#)**

**Only one "donation" needed per manual, not per multiple section of a manual !**

**The large manuals are split only for easy download size.**

---

---

# *Leica*

---

---

**INSTRUCTIONS**  
**for the use of the Leica Camera**  
**Models c, f & g**

**ERNST LEITZ, WETZLAR AND LONDON**

## SECTION ONE: Leica c Series

# *Leica IIIc*

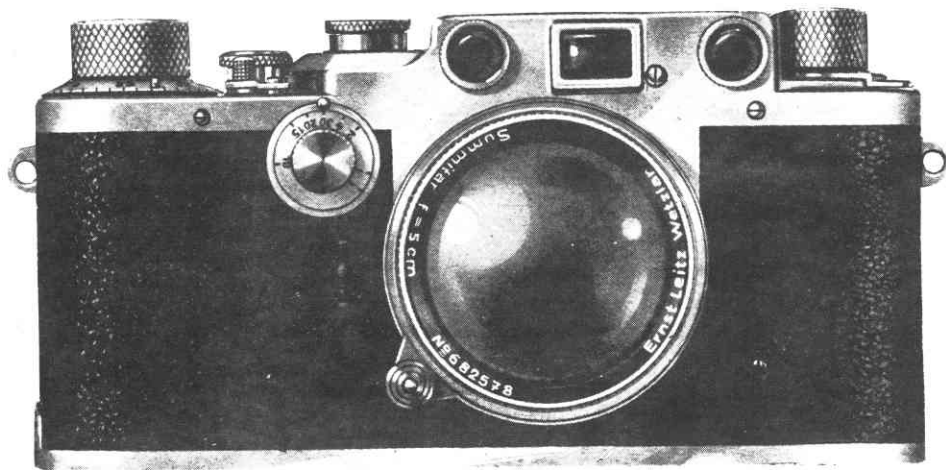

### The **LEICA** is a constant companion . . .

it records your child's first steps, shares your holiday pleasures, chronicles sporting events and catalogues everyday incidents. To the explorer in the tropics or at the poles, to the scientist in his laboratory, to the technician, the artist and the professional photographer it is an ever-ready and reliable servant. To you also the LEICA will become a faithful companion and trusty friend as it has to thousands of LEICA enthusiasts all over the world, bringing pleasure, profit and success.

A thorough understanding of your LEICA and complete mastery of technique are however essential. These instructions will familiarize you, step by step, with the

LEICA if you have not operated one before. Practise every operation with the unloaded camera until you have mastered it. In this way you will quickly master procedure and soon be able to enjoy your own good photographs.



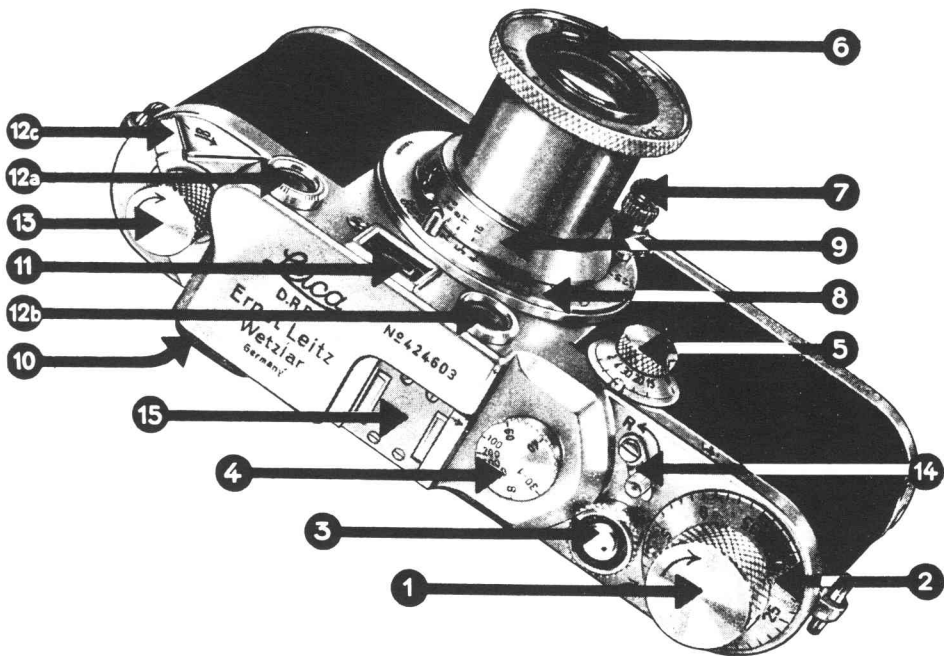

- 1 WINDING KNOB,  
advances the film and winds the shutter  
in one operation
- 2 AUTOMATIC EXPOSURE COUNTER
- 3 SHUTTER RELEASE
- 4 FAST SHUTTER-SPEED DIAL  
for speeds from  $\frac{1}{30}$  sec. to  $\frac{1}{1000}$  sec.  
and "Bulb"
- 5 SLOW SHUTTER-SPEED DIAL  
for speeds from  $\frac{1}{30}$  sec. to 1 sec. and "Time"
- 6 IRIS DIAPHRAGM ADJUSTMENT
- 7 FOCUSING LEVER
- 8 DISTANCE SCALE
- 9 VIEWFINDER WINDOW
- 10 TWIN EYEPIECE viewfinder and rangefinder
- 11 VIEWFINDER WINDOW
- 12a, 12b, 12c RANGEFINDER WINDOWS
- 12c RANGEFINDER EYEPIECE ADJUSTMENT
- 13 REWINDING KNOB
- 14 REVERSING LEVER
- 15 SHOE for special viewfinders and other  
accessories

Set reversing lever  
to **A** (= advance)

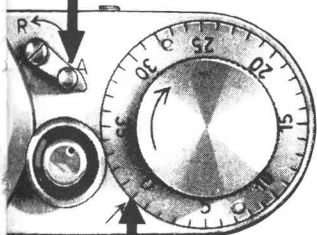

After loading with film  
set exposure counter to 0

**1** TURN WINDING KNOB,  
in the direction indicated by the arrow until it comes to a stop. This operation simultaneously winds the shutter and advances the film for the next exposure. Double exposures are thus prevented.

**2** THE EXPOSURE COUNTER  
automatically registers the number of exposures made provided it was set to 0 when the new film was inserted. Note: the dial may be turned in an anti-clockwise direction, independently of the knob.

**3** SHUTTER RELEASE  
Press the button gently and firmly, avoiding any jerking movement. Use the index finger of the right hand when the camera is held horizontally, or the right thumb when a vertical picture is being made. A cable release may be screwed into the release button when required.

*Routine Practice:* Set exposure counter to 0, wind and release shutter repeatedly, noting the action of the counter.

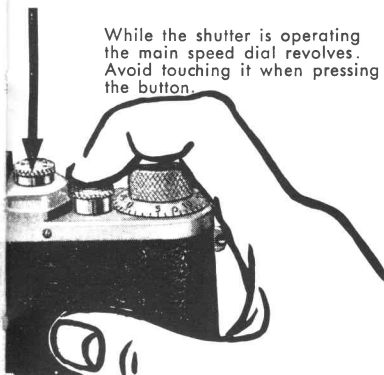

While the shutter is operating  
the main speed dial revolves.  
Avoid touching it when pressing  
the button.

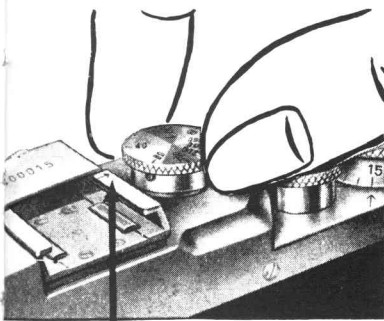

After winding shutter, lift main speed dial, turn it until the desired speed is opposite the arrow and allow the dial to drop into its catch. Those with a delicate touch will note that at  $\frac{1}{1000}$  sec. the dial will not drop back quite so deeply.

## SETTING THE SPEED DIALS



The old fashioned invitation by the portrait photographer to "watch the birdie" has given place to the quiet click of the LEICA shutter.

Modern lenses and emulsions have reduced exposure times from minutes to fractions of seconds.

The LEICA Model IIIc has two shutter speed dials: the main dial on the top and the slow speed dial on the front of the camera.

## **4** MAIN SHUTTER SPEED DIAL (Top)

The engraved figures are the denominators of the fractions of seconds they represent, e. g. 40 indicates  $\frac{1}{40}$  sec., 1000 signifies  $\frac{1}{1000}$  sec. and so on. The speed is set after winding the shutter by raising the dial and turning it until the desired figure falls opposite the arrow. It is then allowed to spring back into its seating. When set to "B" (bulb or brief time) the shutter remains open so long as pressure on the

release button is maintained. When the shutter is rewound the dial returns to the position occupied before release. The dial need not, therefore, be adjusted unless a different speed is required.

When exposures longer than  $\frac{1}{20}$  sec. are required the slow shutter speed dial is brought into play as indicated overleaf.

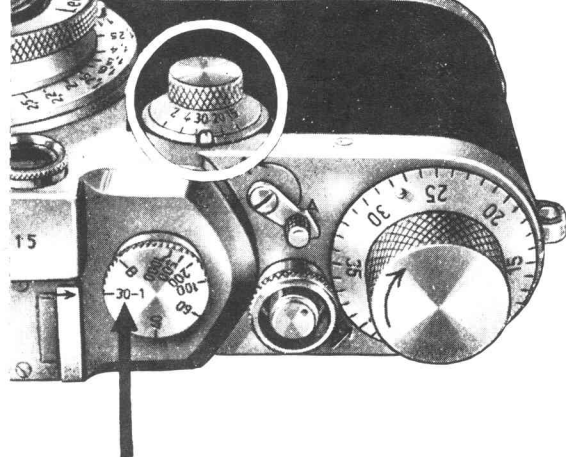

#### IMPORTANT RULE:

For exposures of  $\frac{1}{30}$  sec. and faster the shutter-speed dial on the top of the camera is set to the desired speed, but the slow-speed dial must be first set to red figure 30. To make exposures longer than  $\frac{1}{30}$  sec., first set the top dial to red mark 30-1. Thus, when working at  $\frac{1}{30}$  sec. both dials are set at red figures.

## 5 SLOW SHUTTER SPEED DIAL

Before setting this dial the top dial must be set to the red index 30-1. *This is most important.* The figures on the slow-speed dial can be read from above and provide for intervals of  $\frac{1}{80}$ ,  $\frac{1}{20}$ ,  $\frac{1}{15}$ ,  $\frac{1}{10}$ ,  $\frac{1}{4}$ ,  $\frac{1}{2}$  and 1 sec., and "Time".

This range also covers speeds intermediate between those marked — thus, set half-way between  $\frac{1}{2}$  and 1 sec. the shutter yields an exposure of  $\frac{3}{4}$  sec. Intermediate speeds are not possible in the faster exposure range. When the slow-speed dial is set to "T", the shutter opens on being released and remains open until the slow-speed dial is turned back a little. A safety catch retains the slow-speed dial at the "30" position. This catch is released by the thumb-nail, as shown on the next page, when slower speeds are required.

## SETTING SHUTTER SPEEDS — Summary:

### Short Instantaneous

Exposures: from  $\frac{1}{30}$  to  $\frac{1}{1000}$  sec.

1. Set slow-speed dial at 30.
2. Wind shutter, lift fast-speed dial and turn to appropriate setting.

### Slow Instantaneous

Exposures:  $\frac{1}{30}$  sec. to 1 sec.

1. Wind shutter and set top speed dial at 30-1.
2. Set slow-speed dial.

### Brief Time (Bulb)

Exposures:

1. Set slow-speed dial at 30.
2. Wind shutter and set top dial at B. The shutter will remain open so long as pressure is maintained on the release.

### Time Exposures:

1. Wind shutter and set top speed dial at 30-1.
2. Set slow-speed dial to T. The shutter opens when pressure is applied to the release button and remains open until the slow-speed dial is turned slightly back.

To release slow-speed dial, press spring catch towards the camera with the thumb-nail as shown.

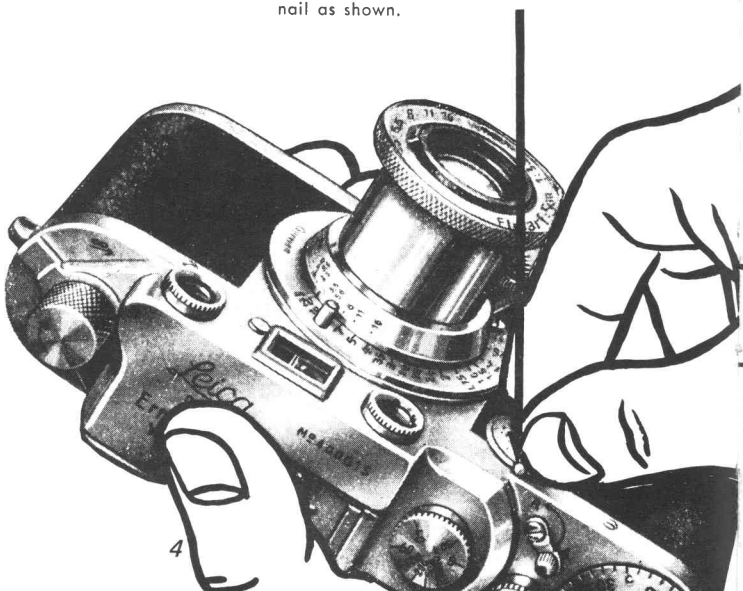

## THE STANDARD LENS OF THE LEICA

is the world-famous ELMAR having a maximum aperture of  $f/3.5$  and a focal length of 50 mm. Of the wide range of LEICA objectives it is the most useful general-purpose lens. It is highly corrected to ensure crisp definition and accurate focus in colour work. Its aperture is sufficiently wide for all but exceptional purposes.

The SUMMITAR  $f/2$  is of the same focal length but passes three times as much light as the ELMAR at full aperture. As is to be expected it is larger and heavier than the standard lens. It is intended for the experienced LEICA-photographer for use under difficult lighting conditions.

Both ELMAR and SUMMITAR are fitted with collapsible mounts, the barrel sliding into the camera body when not in use. The lens is drawn out and locked in position by a slight clockwise turn, and returned to its collapsed position by reversing the movements.

*Routine Practice:* 1. Draw out! Lock!  
2. Unlock! Push back!

A bluish sheen characterises the "coated" or "bloomed" LEICA objectives. The coating, by reducing surface reflection, minimises light scatter and markedly improves the brilliance of the picture.

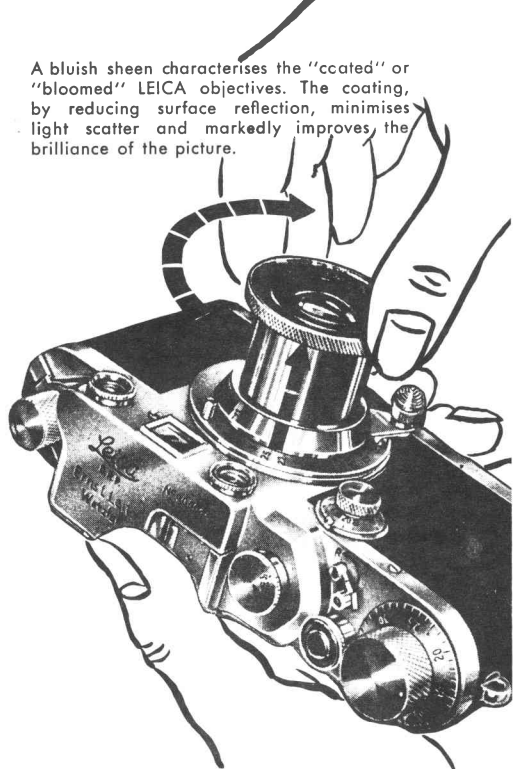

## CHANGING LENSES

All LEICA lenses are interchangeable and will fit any LEICA camera (except very early models). To change a lens hold the camera horizontally, lens pointing upwards, in the left hand and with the right hand grasp the lens close to the camera body and unscrew it by turning anti-clockwise. To fit the alternate lens, hold the camera as described and present the lens to the flange in such a way that the focusing lever (7) is directly in front of the viewfinder window (11). Engage the threads by a slight anti-clockwise turn and screw home by

turning the lens mount in a clockwise direction. The lens tube should be drawn forward and locked before being fitted to the camera.

When the lens is detached the shutter is visible. It is made of a special rubberised cloth, unaffected by temperature, while its flexibility ensures smooth running. Below the upper rim of the flange opening will be seen the lever which couples the focusing adjustment and the rangefinder. It is actuated by a helix on the lens barrel.

*Rule:* Do not change lenses in direct light. Turn away from the sun and work in the shadow of the body. When carrying spare lenses, fit an aperture cap to protect the precision coupling mount. Fit a lens cap over the front component.

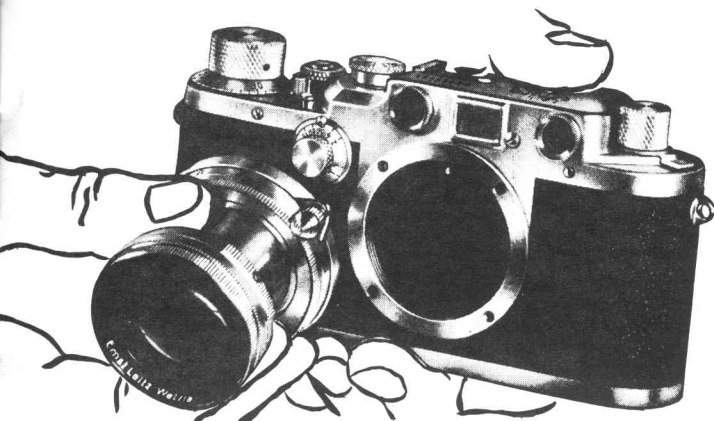

## 6 IRIS DIAPHRAGM ADJUSTMENT

The human eye is able to adapt itself to varying intensities of light by dilation or contraction of the pupil. The lower the light intensity the wider the pupil becomes and vice versa. The "pupil" of the photographic objective is enlarged or reduced by means of an iris diaphragm. The light-passing value of a lens is governed by the ratio of its focal length to the diameter of the "pupil", and is usually referred to as the "aperture" or "stop".

The numerical value of the stop is stated either as a ratio, thus 1:3.5 or, commonly f/3.5. A lens of this value has a focal length three and a half times as great as the diameter of the pupil. Theoretically, all lenses having the same f. number pass the same amount of light for the purposes of exposure.

It is usual to graduate the aperture scale on photographic lenses so that the values vary in a 2:1 ratio. Thus, stopping down one division demands a doubling of exposure time, other conditions being equal.

The following table shows the relation between aperture value and exposure time:

Lens aperture:	1,4	2	2,8	(3,5)	4	5,6	8	11	16	22
Relative exposure time:	0,5	1	2	(3)	4	8	16	32	64	128

## 7 FOCUSING the LENS

All LEICA lenses having a focusing lever are automatically locked at the infinity ( $\infty$ ) position. To release the lever for focusing on nearer planes press the knob at the end of the lever.

*Don't forget:  
ELMAR 50 mm. and SUMMITAR 50 mm. lenses have collapsible mounts. The lens barrel must be drawn out and locked before focusing. (See page 5).*

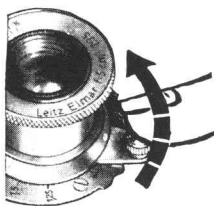
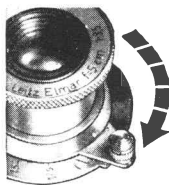

## 8 DISTANCE SCALE

Normally, actual distances do not interest LEICA photographers as focusing is effected by the rangefinder. The distance scale, therefore, is of importance only when referring to the "Depth of Field" scale described on page 7.

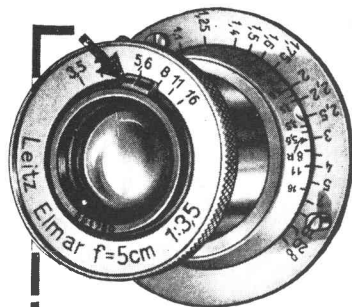

LEICA lenses ELMAR 50 mm., ELMAR 35mm. and HEKTOR 28mm. have the aperture scales engraved on the front of the lens mount. The iris is opened and closed by adjustment of a small finger-piece engraved with an index line. On all other LEICA lenses the diaphragm is controlled by means of a milled ring.

## LENS APERTURE and EXPOSURE TIME

### Example:

Assuming an exposure time of  $1/80$  sec. is correct for a diaphragm setting of f/5.6, the exposure time must be doubled, i. e. increased to  $1/40$  sec. if the diaphragm is stopped down to f/8, other conditions being equal. On the other hand, if the stop were opened up to f/2, only one eighth of the exposure at f/5.6 would be needed, viz.  $1/640$  sec. For practical purposes an exposure of  $1/200$  sec. would be used. Slight differences such as this are of no significance in practice and are covered by the latitude of modern films. Thus, if a meter indicates an exposure of  $1/200$  sec. the LEICA user would use his nearest speed— $1/250$  sec.

Note that where the indicated exposure falls half-way between two standard speeds, the longer exposure is given.



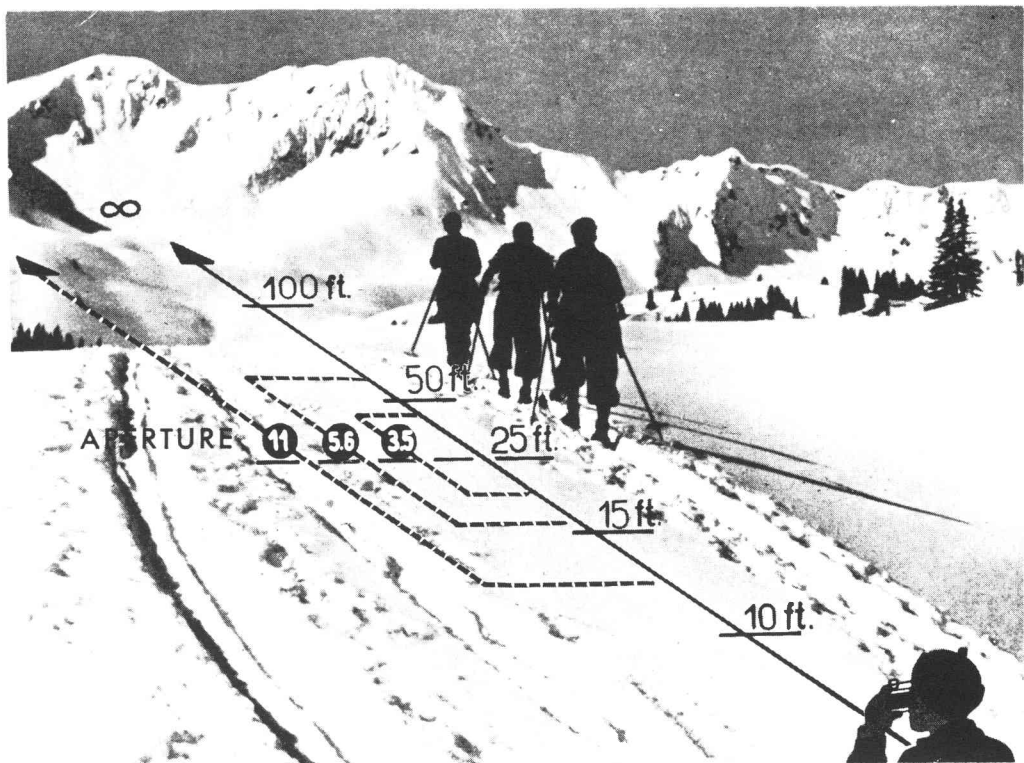

## 9 DEPTH OF FIELD SCALE

An object is most sharply defined in a photograph when it lies at the distance on which the lens is focused. Definition would gradually deteriorate if the object were moved nearer the camera until a point would be reached when definition would be quite unsatisfactory. Similarly, definition would deteriorate, although not so rapidly, if the object were moved away from the camera. The distance between the nearest plane and the furthest plane at which objects are sufficiently sharply defined is known as the "Depth of Field" (frequently erroneously called "Depth of Focus"). It varies with the distance focused upon and the aperture of the lens. The nearer the principal object and the larger the stop of the lens the shallower the depth of field and therefore the more critical must focusing be.

A scale on the LEICA enables the depth of field to be read at each aperture and each distance setting down to 3,5 feet. Objects at distances between those indicated on the scale will be sufficiently sharply defined.

*Example: with a standard focal length of 50 mm., when the distance scale is set at 25 feet and the lens aperture at f/3.5, the depth of field extends from 20 feet to 40 feet. With the lens stopped down to f/5.6 it will extend from 16 feet to about 60 feet. At f/11 all objects beyond 12 feet will be in focus.*

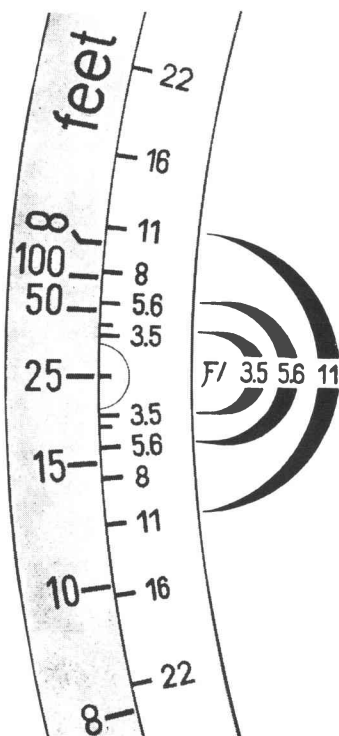

## GENERAL RULES FOR STOPPING DOWN

1. *Objects Most Sharply Defined* are those at the distance at which the lens is focused. Therefore always focus carefully on the centre of interest of the subject.
2. *Snapshots*: Stop down to  $f/5.6$  and focus on principle object. The depth of field will usually be sufficient.
3. *Long Distance Views Without Foreground Interest*: Set lens to infinity and stop down to  $f/5.6$  or  $f/8$ .
4. *Landscapes With Foreground*: Stop down so that the depth of field scale indicates a range extending from the foreground distance to infinity.
5. *Portraits*: Use full lens aperture and focus accurately on the eyes. The sitter should be sharply defined and the background subdued by being diffused.

## VIEWFINDER and RANGEFINDER:

### 10 TWIN-EYEPIECE

This carries the eyepieces of both viewfinder and rangefinder so that only a slight movement of the head is necessary when changing from one to the other.

*Important to those with defective eyesight:* Correction lenses to suit the user's sight can be fitted to the twin eyepiece, enabling him to operate his LEICA with his eyeglasses removed and his eye placed close to the eyepiece. The correction lenses are prepared to the user's optician's prescription.

### 11 VIEWFINDER

The built-in viewfinder indicates the view embraced by the standard 50 mm. lenses. When objectives of other focal lengths are in use the universal viewfinder, which fits into the shoe (15) must be brought into use.

### *The Second Index Line*

*marked R on distance scale is used for infra-red photography. First focus accurately on the object in the usual way, then adjust the lens mount until index line R registers with the distance indicated by the rangefinder setting. Exceptions: When working with wide-angle lenses, no adjustment is necessary.*

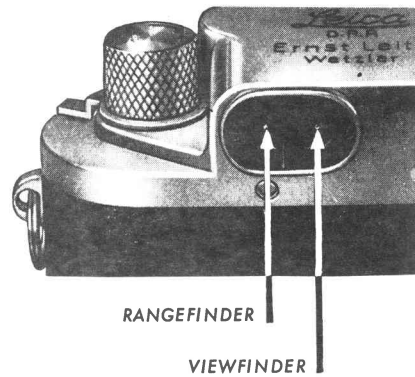

*Place the eye close to the twin eyepiece. Care should be taken to look squarely through the centre of each eyepiece.*

## 12 ab COUPLED RANGEFINDER



In miniature photography accuracy of focus is of extreme importance to ensure the necessary fine definition so essential if sharp enlargements are to be made.

The visual examination which used to take place under the black cloth is now accurately and easily carried out by movement of a single finger.

The rangefinder coupled with the LEICA lens measures the distance and at the same time focuses the lens accurately on that distance.



Focusing is effected by means of the lens focusing lever (7). When the lens is set at "infinity", near objects appear to be "double" when viewed through the rangefinder. When the focusing lever is adjusted so that the two images of an object coincide the lens is focused on that object. All interchangeable LEICA lenses up to 13.5 cm. focal length are automatically coupled with the rangefinder when screwed into the camera body.



Out of focus



Correct focus

### How The Coupled

#### Rangefinder Works:

As the lens is focused, the backward and forward movement is communicated via a lever to the rangefinder, the mechanism of which is made to the high degree of precision associated with fine microscopes and similar precision instruments.

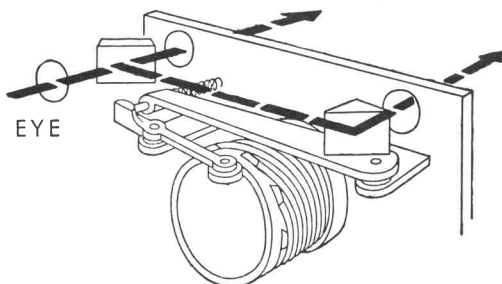

## 12 c ADJUSTMENT OF RANGEFINDER

### TELESCOPE

The accuracy of the LEICA rangefinder is augmented by a built-in telescope having a magnification of 1.5. By means of the small lever (12c) it may be focused on distant objects. The telescope will also compensate for slight eyesight defects (between  $-2$  and  $+1.5$  dioptres).

**AN EXPERIMENT** to demonstrate the operation of the rangefinder. Sight, through the rangefinder, an object about 12 to 15 feet away, the lens being set to "infinity". Cover the left hand rangefinder window with the middle finger of the left hand. Look straight into the rangefinder eyepiece (never look obliquely through it). The object will be seen

in a small circular field. Adjust lever (12c) until the greatest possible sharpness is obtained. Now remove the finger from the window and a double image of the object will be seen in a larger circular field. Adjust the focus of the lens by lever (7) until the two images coincide. The lens is then accurately focused on the selected object. Unless the small field appears exactly in the centre of the larger, the line of sight is oblique and incorrect. Bearing this in mind will quickly enable the LEICA user to focus rapidly and accurately.

When working at short distances it is advisable to focus the lens by scale on the appropriate distance and correct slight difference by approaching or receding from the subject until the rangefinder images coincide.



## HOLDING the LEICA:

Grip the LEICA with the right hand so that the rounded end of the base-plate rests in the palm. The index finger should rest lightly on the shutter-release button. It is important that the ball of the thumb counteracts the pressure of the finger on the release. The other end of the camera is gripped in the left hand, with the index finger on the focusing lever. Hold the camera steadily against the head with the twin eyepiece immediately in front of the eye. Press the elbows to the chest and stand with the feet well separated.

Press the release button gently but firmly, taking care not to jerk. Apply pressure with the forefinger only and maintain pressure until the shutter has completed its run.

## THE WRONG WAY:

The camera is not held firmly and may give way to the pressure on the release button because the ball of the thumb is not counteracting it. The result will almost certainly be a blurred picture. In addition to the method of holding the LEICA described on page 7, experienced users hold their breath at the moment of release.

Some enthusiasts boast that they are able to hold the camera steady for a whole second. However, it is always safer to set the camera on a firm support when using the slow speed dial.





## VERTICAL PICTURES:

Grip the LEICA with the right hand with the thumb on the release button and the fingers exerting counter pressure. The upper end of the camera is grasped with the left hand, one finger of which operates the focusing lever. The top of the camera should rest against the forehead. Thus held, the camera can be operated without jerking.

Slow-speed, hand-held snapshots are not difficult . . .

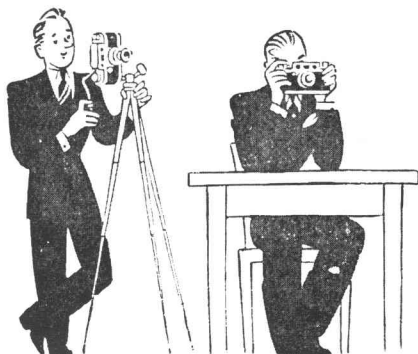

## THE SECOND METHOD:

of taking vertical pictures, popular when changing from horizontal to vertical position or vice versa.

Grip the LEICA as described on page 10, then turn to the vertical position. (A hat should not be worn).

. . . if ingenuity is called upon.



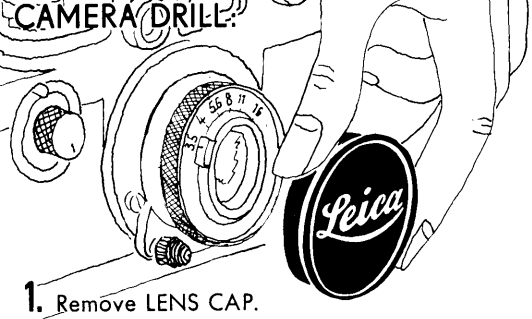

1. Remove LENS CAP.

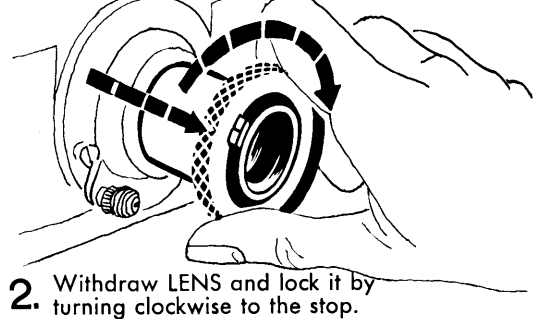

2. Withdraw LENS and lock it by turning clockwise to the stop.

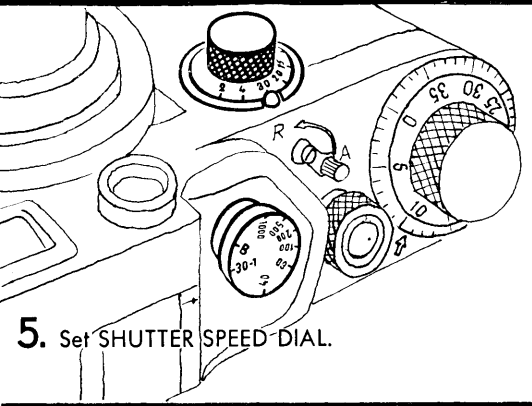

5. Set SHUTTER SPEED DIAL.

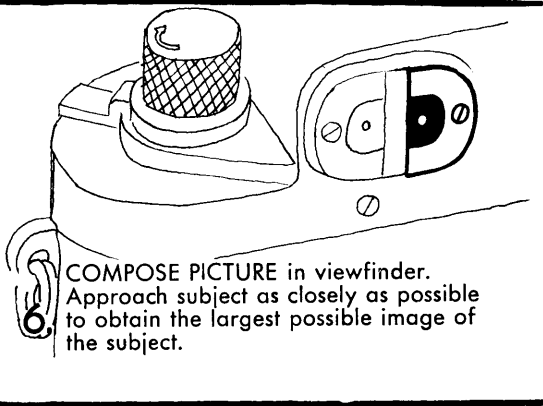

6. COMPOSE PICTURE in viewfinder. Approach subject as closely as possible to obtain the largest possible image of the subject.

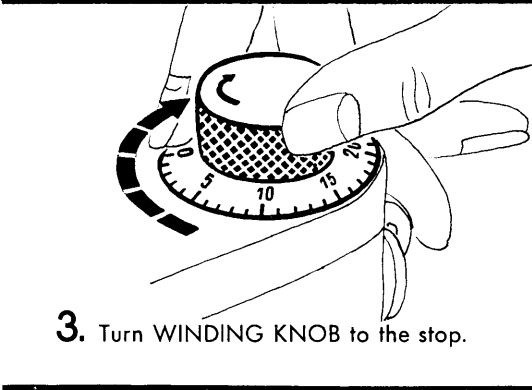

3. Turn WINDING KNOB to the stop.

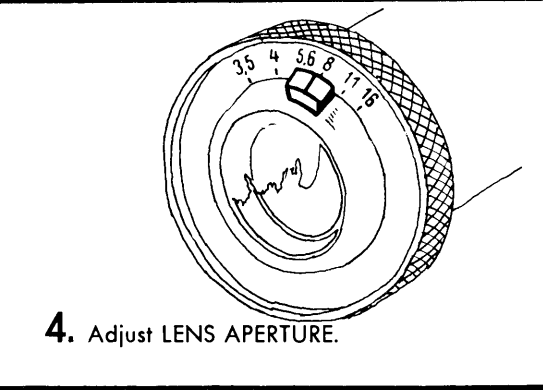

4. Adjust LENS APERTURE.

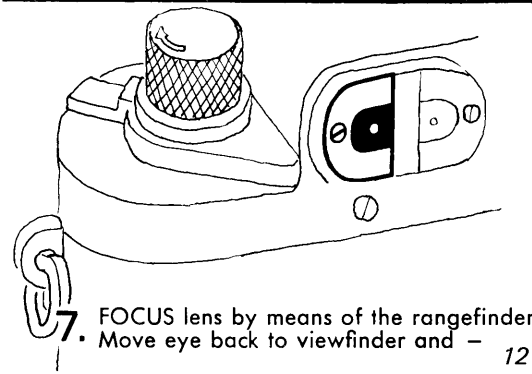

7. FOCUS lens by means of the rangefinder. Move eye back to viewfinder and -

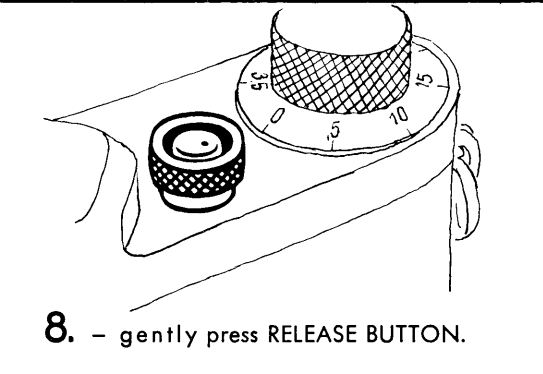

8. - gently press RELEASE BUTTON.

## FILM CARTRIDGES, SPOOLS and other CONTAINERS

The principal manufacturers supply 35 mm. perforated film as used in the LEICA in various degrees of sensitivity etc. and issue the following:

1. *Daylight Loading Cartridges* which are simply inserted in the camera in daylight in the same way as LEICA film cassettes. They should not be reloaded for a second time.

2. *Daylight Loading Spools* which consist of a standard length of film with opaque paper leaders and wound on a centre spool. Directions for use are supplied with the spools.

3. *Darkroom Loading Spools* which contain ready-trimmed lengths of film which require to be loaded into the LEICA cassette in the dark-room.

4. *Bulk Supply*. This is available in lengths of 5, 10, 15 metres and upwards. In the darkroom the required length is cut off, loaded into the LEICA cassette and trimmed (see page 20). The LEICA film cassette holds 1.6 m. (approx.  $5\frac{1}{4}$  feet) of film, sufficient for 36 exposures.

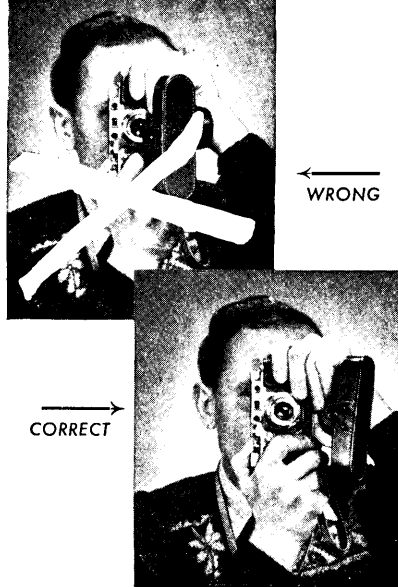

### The Ever-Ready Case:

The LEICA is best kept and carried in the ever-ready case. To remove the LEICA from the case, loosen the bottom screw.

Caution: When using a new case and when taking vertical pictures care should be taken that the hinged portion does not swing in front of the lens.

## LOADING the LEICA

The fact that exposures as short as  $\frac{1}{500}$  to  $\frac{1}{1000}$  sec. can produce successful pictures is sufficient indication of how minute an amount of light may spoil a film. LEICA cassettes and daylight loading cartridges are light-tight but even so, they should never be exposed to direct sunlight. Always load and unload the camera in the shadow of the body in the absence of other shade.

Before opening the LEICA make sure that the film has been rewound into its cassette. If there is any doubt about the camera being loaded, pull out the rewinding knob (13) and turn it in the direction of the arrow. If resistance is felt the camera is loaded and the film should be wound back into the film cassette (see page 16).

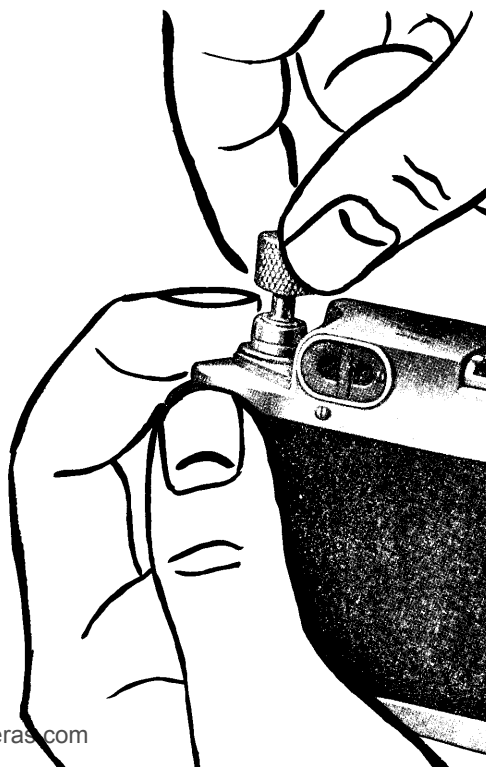

## TO LOAD THE LEICA :

1. Before inserting a new film cassette, set reversing lever (14) to **A** (**A**dvance). Wind and release the shutter to make sure that it is in order. Wind the shutter again but do not release it.
2. Open the camera by raising the locking handle on the baseplate and turning to

„OPEN“ and lift the baseplate. (Some models are marked „AUF“ (open) and „ZU“ (closed).)

3. Remove the take-up spool from the camera.
4. Place the LEICA on the table as shown in the illustration.

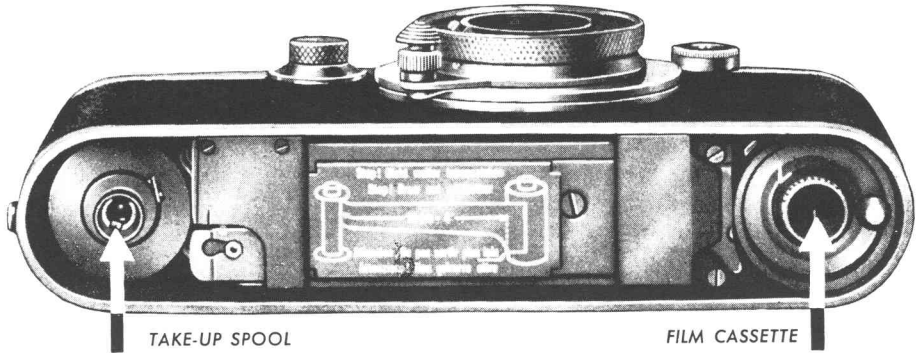

## LOADING THE LEICA

5. Hold the take-up spool in the left hand and the loaded film cassette in the right. Both knurled heads should point downwards (see illustration). Insert the trimmed end of the film under the clamping spring of the take-up spool as far as it will go. The perforated edge of the film should abut the spool flange.
6. Draw the trimmed leader strip from the film cassette slot until two (but no more) perforations on the trimmed edge of the film are visible. (See illustration, page 15). The curved mark on the outer shell of the LEICA cassette indicates the correct position of the film.

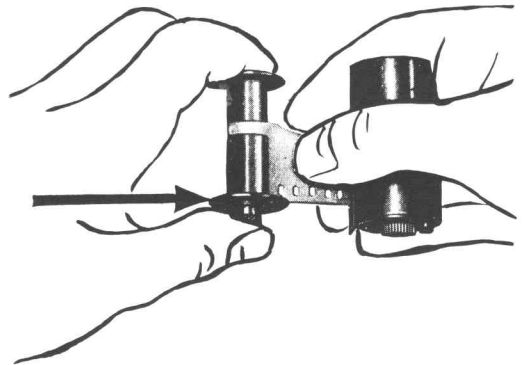

Correct trimming of the film is important. Study instructions and illustrations on page 20.



## LOADING THE LEICA

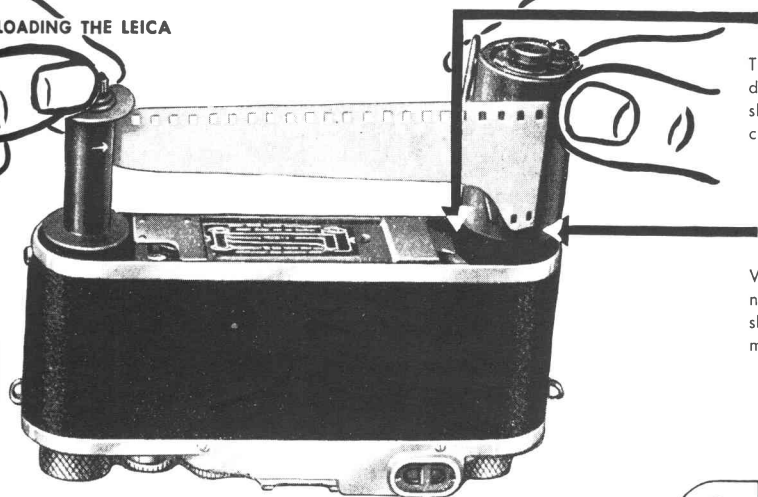

The safety spring of the standard LEICA film cassette should always lie in this corner.

With properly trimmed film no more than two perforations should be visible on the trimmed edge.

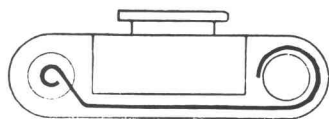

Check the path of the film by this diagram: the emulsion side must face the lens.

7. Introduce the take-up spool and film cassette into camera simultaneously, knurled heads pointing upwards. The trimmed film will then enter the slot along the back of the camera. If the cassette will not drop right down, turn the rewinding knob (13) slightly.

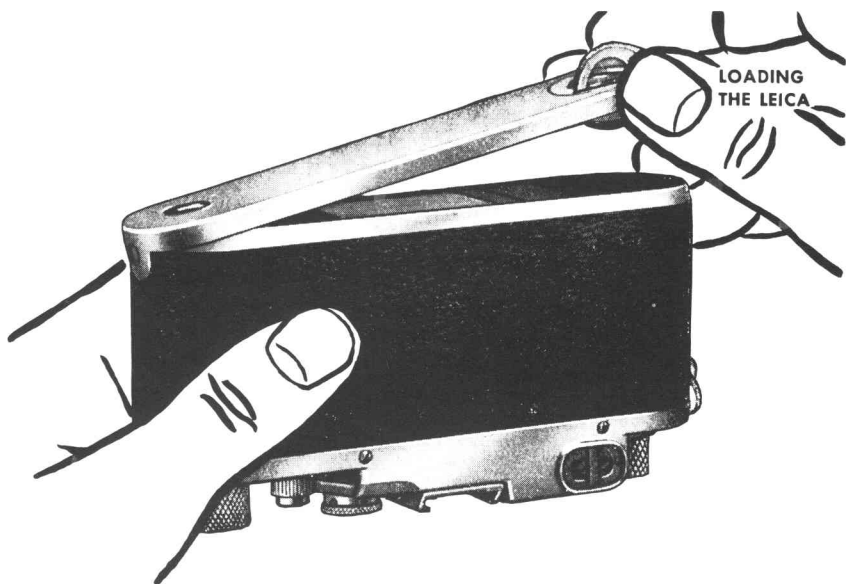

## LOADING THE LEICA

8. Hook the baseplate over the pin, close it and turn the locking handle to "CLOSED" (or ZU). The camera is now light-tight.

## LOADING THE LEICA

9. Turn the rewind knob (13) carefully in direction indicated by the arrow (page 2) until a slight resistance is felt. This will have tightened the leader strip. Press the release button (3) and turn winding knob once again.
10. Turn exposure counter (2) anti-clockwise to 0, release shutter and again turn the winding knob. While the winding knob rotates clockwise, the rewind knob should turn in the opposite direction to the arrow, viz. anti-clockwise. This will indicate that the film is travelling properly. The exposure counter will now be pointing to 1 and the LEICA is ready for use.

## UNLOADING THE LEICA

When the full length of film has been exposed it will be impossible to turn the winding knob without exerting undue force. It will be necessary to rewind the film into the cassette. Before doing so verify that the slow-speed dial is not set to T or the shutter might be open and the film would be exposed while being rewound. To be doubly sure fit the lens cap while rewinding.

1. To unload the camera set the reversing lever (14) to **R** (Rewind). This disengages the automatic coupling of the film transport and the shutter mechanism.
2. Pull up the rewind knob (13) and turn in the direction of the arrow until resistance is felt. This will indicate that the film has been unwound from the take-up spool and is being held merely by its tip under the spring of the take-up. Wind to overcome resistance, and after two complete turns the film will be completely rewound into the cassette.

If the film has not been correctly inserted . . . it may disengage from the take-up spool and will not advance. This fault will be recognized by the rewind knob failing to rotate while the winding knob is being turned. The film must be re-inserted: (1) set reversing lever (14) to **R**, (2) turn rewind knob (13) in the direction of the arrow, *only so long as the release button continues to rotate*. When the latter ceases to rotate the film will have passed the release shaft and only a very short length will be protruding from the mouth of the cassette. Should the end of the film be drawn into the cassette it will be necessary to go into a darkroom to withdraw the leader.

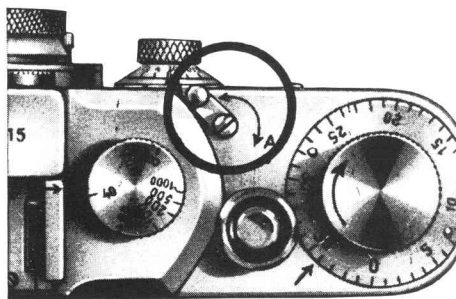

If a partially exposed film is removed from the camera and the unexposed portion is to be used at a later date, the film must not be fully rewound into the cassette. Watch the release button carefully when rewinding and stop as soon as it ceases to turn. (See also page 30.)

3. After rewinding the film the baseplate may be removed and the cassette withdrawn. Protect loaded cassettes from dust and light by storing in the original containers.

## STANDARD LEICA FILM CASSETTE

The standard LEICA film cassette holds 1.6 m. (about  $5\frac{1}{4}$  feet) of 35 mm. film, sufficient to make 36 exposures 24 x 36 mm. in size. Obviously, shorter lengths may be inserted.

The cassette consists of three parts: outer shell, inner shell, and centre spool.

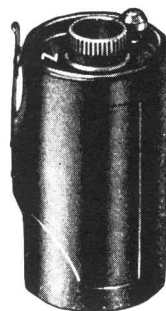

B = Complete Film Cassette

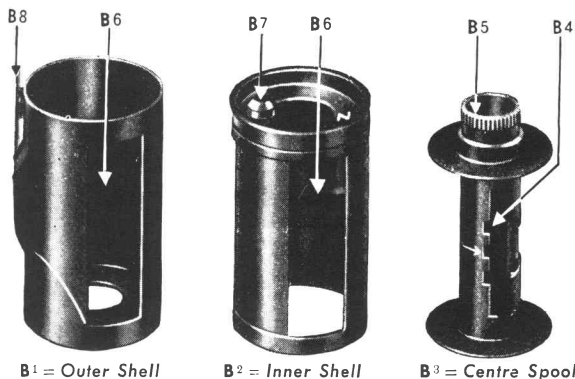

B<sup>4</sup> = Spool Slot

B<sup>5</sup> = Knurled Head of Centre Spool

B<sup>6</sup> = Mouths of Cassette  
(outer and inner shell)

B<sup>7</sup> = Knob on Inner Shell

B<sup>8</sup> = Safety Spring

A locating groove on the inner shell and a corresponding pin inside the rim of the outer shell control the movements of the two components when opening or closing.

### Opening the Cassette:

Flex the safety spring slightly with the left forefinger. With the right hand turn the inner shell, by the knob, as far as it will go in a clockwise direction and withdraw it completely. (See illustration, page 18.)

### Closing the Cassette:

Insert the inner shell into the outer in such a manner that the mouths coincide. The pin of the outer shell slides in the locating groove of the inner shell until a stop is reached. The cassette is locked by turning the inner shell in an anti-clockwise direction until the safety spring engages.

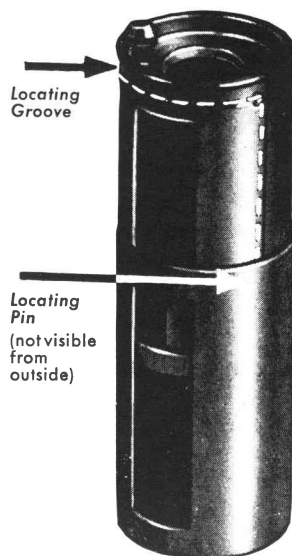

## LOADING THE CASSETTE:

(These instructions (pages 17-20) do not apply to daylight loading cartridges.)

*Practice loading the cassette in daylight, using old film. When it is possible to carry out every stage with the eyes closed it will be safe to attempt loading highly sensitive panchromatic film in absolute darkness.*

1. Open film cassette and arrange the three parts on a table.
2. Take the spool in the right hand, forefinger on the knurled head, thumb in the hollow opposite the arrow, as shown in fig. 2.
3. Insert tapered end of film straight into slot (B<sup>4</sup>), emulsion side away from the body. (In older types of spools the end of the film is inserted under a retaining spring.)

*The emulsion side of the film is easily identified even in the dark as film normally curls with the emulsion on the inside. When in doubt, moisten a finger tip and touch the film lightly. The emulsion side will feel sticky.*

4. Wind the film on to the centre spool reasonably tightly, emulsion side inward. If possible, use a winder as illustrated on page 19.

5. Fold the free end of the film back sharply, just behind the second perforation so that it will later emerge through the mouth of the cassette.

6. Insert the centre spool, knurled head first, into the inner shell with the bent end of the film appearing in the mouth.

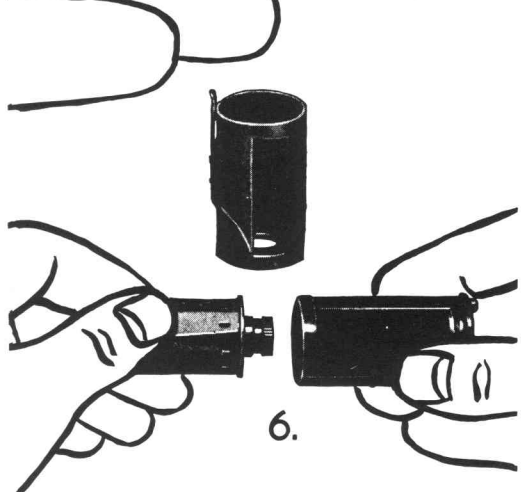
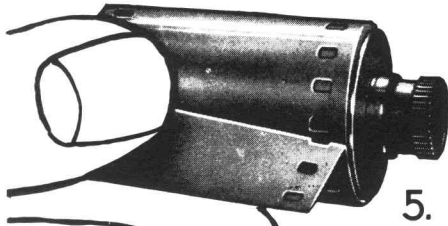
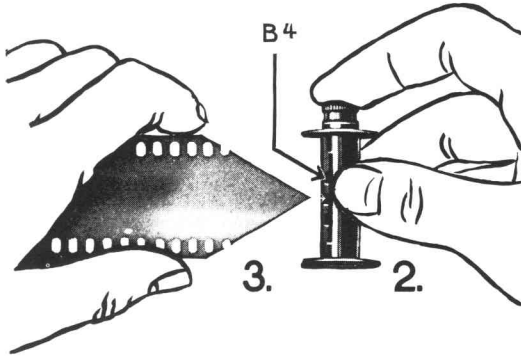
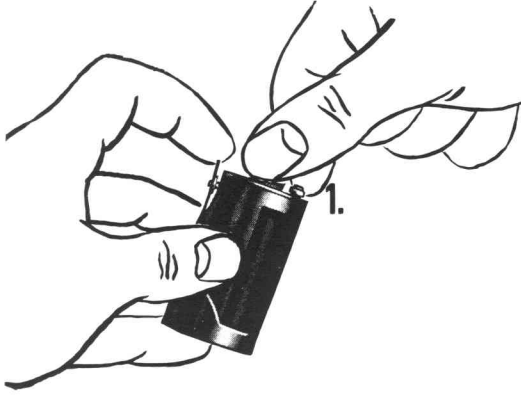

## LOADING THE FILM CASSETTE IN THE DARKROOM

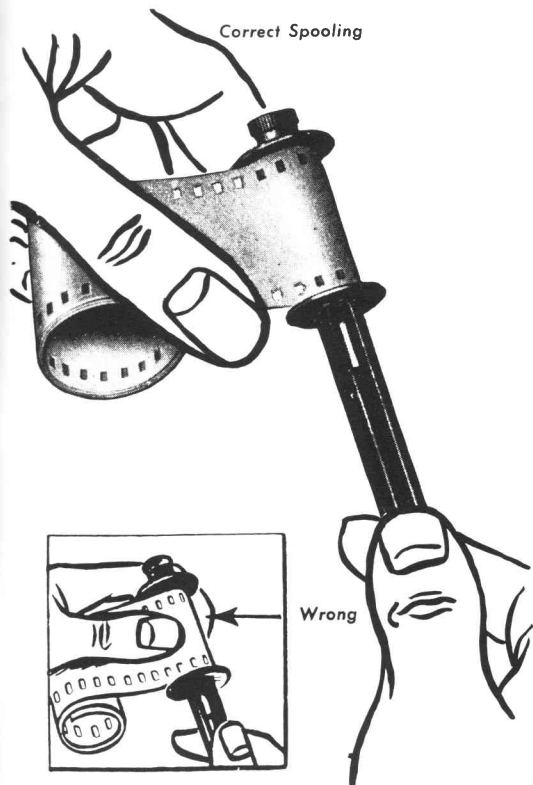
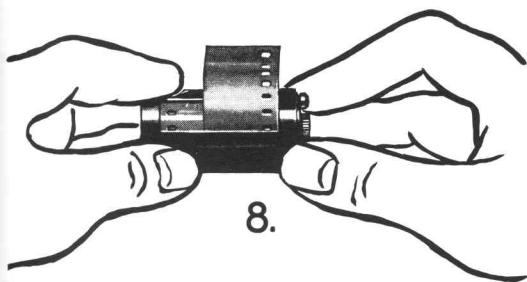
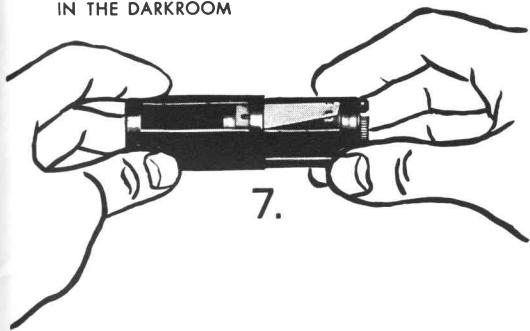

7. Slide the outer shell on to the inner with the mouth coincident. Draw out two or three inches of film.

8. Close the cassette by turning the inner shell anti-clockwise until it is locked by the safety spring.

9. Draw out leader only so far that the trimmed portion registers with the curved line engraved on the outer shell.

*Protect loaded film cassettes from light and dust by keeping them in the containers supplied for the purpose.*

## SPOOLING THE FILM IN THE DARKROOM

When using trimmed lengths or bulk film the cassette must be loaded in the darkroom. The hand film winder will prove a great help. It is fitted into the bottom of the centre spool and greatly assists winding.

*During spooling the film must not be touched on either back or emulsion side, but held lightly by the edges, allowing it to slide between thumb and forefinger.*

## TRIMMING THE FILM:

Film supplied in daylight cartridges and cut lengths is ready trimmed. When film is cut from bulk supply it must be properly trimmed before being loaded into the cassette. Careless trimming may lead to trouble such as torn perforations resulting in the jamming of the transport mechanism by small pieces of film.

Film may be trimmed with scissors, but the beginner is strongly advised to use the LEICA trimming template to ensure accurate trimming.

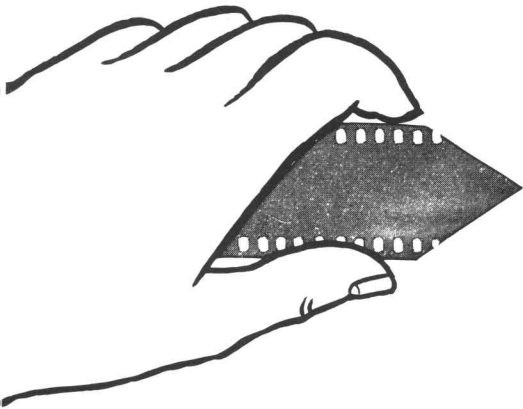
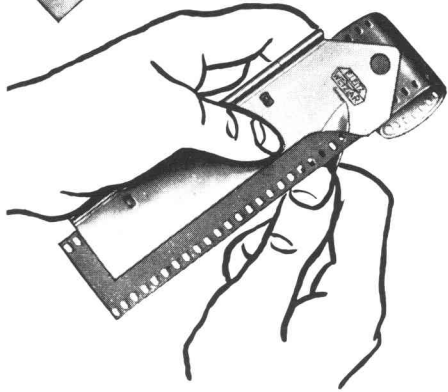
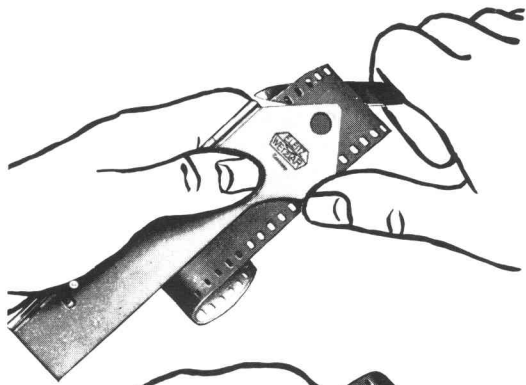

**THIS** is how the correctly trimmed inner end of a film should appear.

**THIS** is how the film should be held – by the edges. Never touch the emulsion side or the back of the film.

**THIS** shows correct trimming of the leader end protruding from the cassette. Special care should be taken not to cut through or damage a perforation.

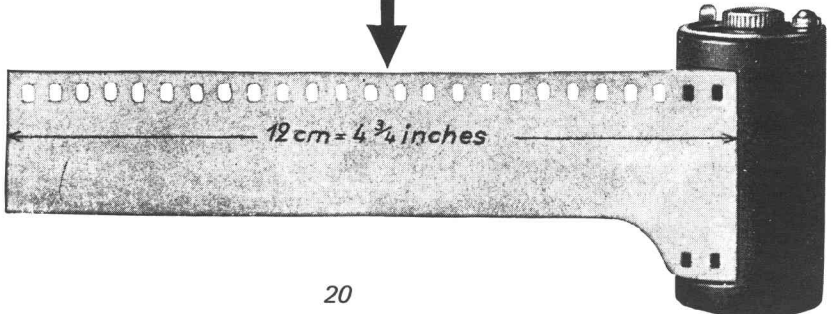

## CHOICE OF SENSITIVE MATERIAL:

A wide variety of films of differing speeds and other characteristics is available, enabling the LEICA photographer to select the type most suitable for any particular purpose.

**Medium Speed Films** with a rating of about  $16/10$  DIN to  $18/10$  DIN are most suitable for general use. They yield high contrast, fine grain images, exhibit wide exposure latitude and possess high resolving power.

**High Speed Films** should only be used under certain circumstances such as poor light, indoor and theatre work and sports photography when high shutter speeds are essential. High speed can only be realised at the expense of some coarsening of grain structure and therefore of resolving power.

**Slow Films** possess particularly fine grain and yield the highest contrast. They are most suitable when the reproduction of fine detail is required and length of exposure is unimportant. The copying of documents and drawings is best done on slow films.

Film manufacturers express the speeds of their materials by various systems. The more frequently used ratings employed by film and meter manufacturers are shown in the accompanying table.

DIN	B. S. & A. S. A.		General Electric	Weston	American Scheiner	European Scheiner
	Arithmetic	Logarithmic				
$10/10$	8	20 <sup>o</sup>	10	6	17 <sup>o</sup>	21 <sup>o</sup>
$11/10$	10	21 <sup>o</sup>	12	8	18 <sup>o</sup>	22 <sup>o</sup>
$12/10$	12	22 <sup>o</sup>	16	10	19 <sup>o</sup>	23 <sup>o</sup>
$13/10$	16	23 <sup>o</sup>	20	12	20 <sup>o</sup>	24 <sup>o</sup>
$14/10$	20	24 <sup>o</sup>	24	16	21 <sup>o</sup>	25 <sup>o</sup>
$15/10$	24	25 <sup>o</sup>	32	20	22 <sup>o</sup>	26 <sup>o</sup>
$16/10$	32	26 <sup>o</sup>	40	24	23 <sup>o</sup>	27 <sup>o</sup>
$17/10$	40	27 <sup>o</sup>	48	32	24 <sup>o</sup>	28 <sup>o</sup>
$18/10$	48	28 <sup>o</sup>	64	40	25 <sup>o</sup>	29 <sup>o</sup>
$19/10$	64	29 <sup>o</sup>	80	50	26 <sup>o</sup>	30 <sup>o</sup>
$20/10$	80	30 <sup>o</sup>	100	64	27 <sup>o</sup>	31 <sup>o</sup>
$21/10$	100	31 <sup>o</sup>	125	80	28 <sup>o</sup>	32 <sup>o</sup>
$22/10$	122	32 <sup>o</sup>	160	100	29 <sup>o</sup>	33 <sup>o</sup>
$23/10$	160	33 <sup>o</sup>	200	125	30 <sup>o</sup>	34 <sup>o</sup>
$24/10$	200	34 <sup>o</sup>	250	160	31 <sup>o</sup>	35 <sup>o</sup>
$25/10$	250	35 <sup>o</sup>	300	200	32 <sup>o</sup>	36 <sup>o</sup>

Scheiner, DIN, ASA/BS (log) ratings progress by three units per doubling of speed. In the other systems, doubling of the speed figure denotes a doubling of the film speed.

*N.B. For films in current production refer to manufacturers literature.*

## CORRECT EXPOSURE:

A good exposure meter markedly simplifies exposure problems, but even without a meter, it is possible to acquire a facility for estimating exposures based on previous experience. From the start, make two different exposures on each subject and compare the result after development. The accompanying table applies to average subjects.

When estimating exposures bear in mind that in a photograph bright objects appear relatively brighter, while dark objects appear darker than they do to the eye. This is because the eye adapts itself to the prevailing light. When making a visual estimate of an exposure, therefore, until extensive experience has been gained in bright light, take a second picture giving one third of the estimated exposure. In dull light make a duplicate exposure giving 3 to 5 times the estimated time.

The above applies to black-and-white film. Colour film has little exposure latitude and the use of an exposure meter is recommended.

Snapshots, Groups, Street Scenes, Houses:	f/5.6	$1/60 - 1/100$
Rapidly Moving Objects, Sports Pictures:	f/4 f/2.8	$1/200 - 1/500$ $1/500 - 1/1000$
Landscapes with foreground:	f/8	$1/30 - 1/60$
Open Landscapes:	f/8	$1/60 - 1/100$
Open Sea, Snow Scenes:	f/8 - f/11	$1/60 - 1/200$
Outdoor Portraits in shade:	f/3.5	$1/20 - 1/40$
Indoor Portraits near window:	f/2 f/3.5	$1/4 - 1/40$ $1/2 - 1/20$

The exposures quoted above are for medium speed films ( $17/10$  DIN) and a clear sky during the summer months between 10 a. m. and 4 p. m. During the spring and autumn double these exposures and in the winter months multiply by four. High-speed films will require only half the exposures indicated.

Bear in mind that geographic latitude also influences exposure. Those shown apply to the temperate zones.

## THE INTERCHANGEABLE LEICA LENSES

offer a wide choice of application from wide-angle to telephoto.

### *General Purpose Lenses:*

ELMAR 50 mm. f/3.5; SUMMITAR 50 mm. f/2

### *Ultra-Speed Lenses:*

SUMMARIT 50 mm. f/1.5; SUMMAREX 85 mm. f/1.5

### *Wide-Angle Lenses:*

SUMMARON 35 mm. f/3.5; ELMAR 35 mm. f/3.5;  
HEKTOR 28 mm. f/6.3

### *Long-Focus Lenses:*

ELMAR 90 mm. f/4; HEKTOR 135 mm. f/4.5

### *Telephoto Lenses:*

TELYT 200 mm. f/4.5; TELYT 400 mm. f/5



## THE UNIVERSAL VIEWFINDER

for all LEICA lenses from 35 mm. to 135 mm. is provided with a parallax compensating lever enabling accurate placing of the subject in the field of view. Special viewfinders such as the sports finder, in which the subject is seen before it enters the actual field of view are available.

### *FILTERS:*

The use of filters is advised even with panchromatic film in order to increase contrast and produce pictorial effects. Yellow, green, orange, red and ultra-violet filters are available.

### *A LENS HOOD*

should be included in every photographer's equipment. In sunny weather it screens the lens from top and side light; in bad weather it protects it against rain and snow.

### *NEAR-FOCUSING DEVICE*

This attachment permits photography at very close range — 1½ to 3 feet (40 cm. to 1 metre). It is inserted between camera and lens and is coupled with the built-in automatic rangefinder of the LEICA.

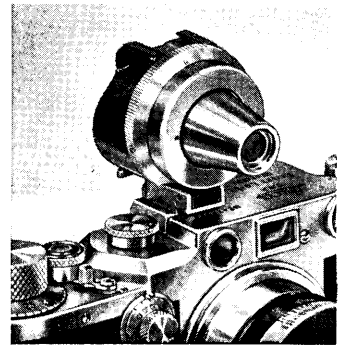

*Universal Viewfinder*

*Near-Focusing Device*





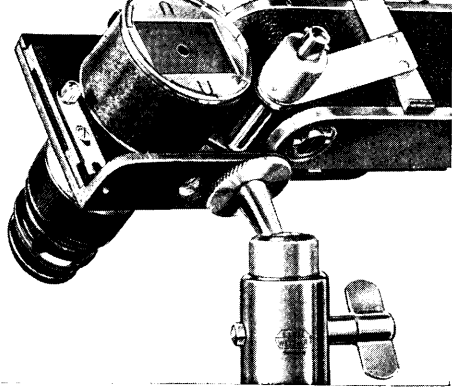

### VISUAL FOCUSING:

In scientific and technical photography it may sometimes be desirable or necessary to examine and focus the image critically on a ground-glass screen. The sliding copying attachment (above) and the mirror-reflex housing (below) afford the advantages of a camera with focusing screen in such applications as the photography of small objects, actual size and low power magnification, photomicrography, reproduction, portrait work etc.

Small Negatives . . . .

### LARGE PICTURES

Not only is it economical for the LEICA photographer to enlarge his own negatives, but it enables him to utilise to the fullest extent the pictorial possibilities of his subjects and to express his individuality in his pictures. It is, too, a fascinating and absorbing process.

THE FOCOMAT ENLARGER is fitted with an automatic focusing device to ensure maximum sharpness of every enlargement without tedious adjustment. It renders enlarging as simple as contact printing. Standard LEICA 50 mm. lenses, ELMAR or SUMMITAR, may be used in the FOCOMAT.

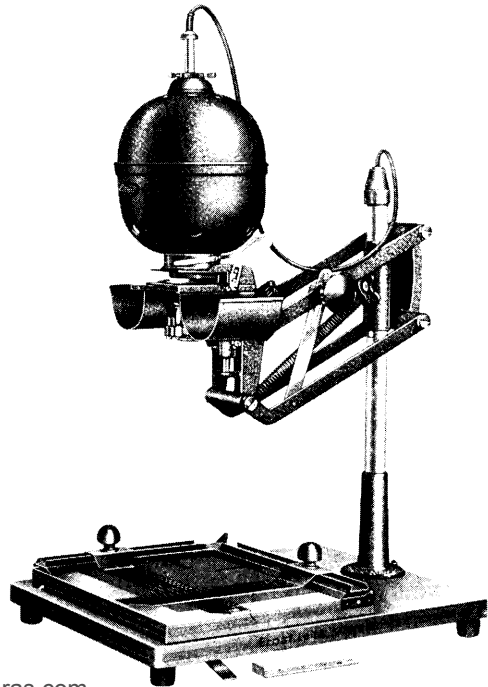

## NEVER TRY . . . .

to repair a LEICA if by any chance it has become damaged. Always take it to an authorized LEICA repair service. The LEICA is built by specialists and only specialists should be entrusted with its repair.



## EVERY LEICA and EVERY LEICA LENS

### bears a REGISTRATION NUMBER

In case of loss or theft it is important that this number be known. Make a note of all serial numbers and carefully preserve it for reference in case of loss. It may help to recover a lost or stolen camera or lens. If you furnish us with the necessary details, all our technical services will be notified and will retain every camera reported.

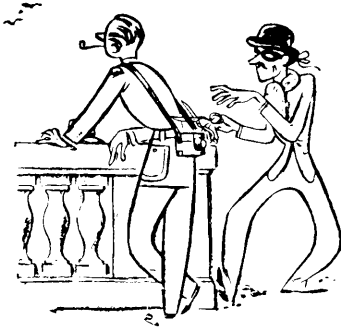

# SECTION TWO: Leica f Series

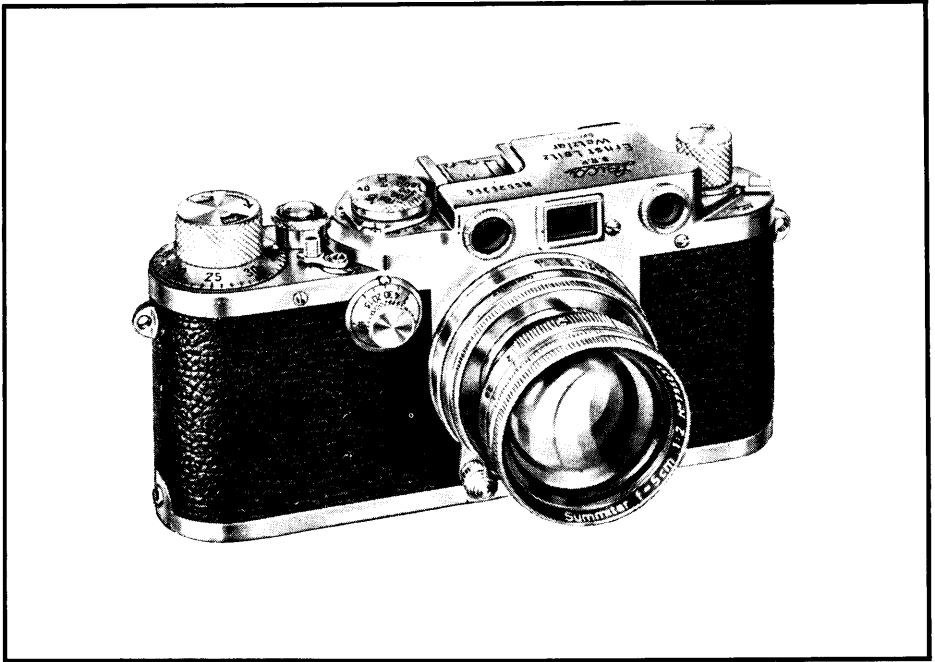

*Leica*

If · IIIf · IIIIf

ERNST LEITZ · GMBH · WETZLAR

LEICA If

21 1 4 2 3 16 18 5 12 10 9 13 15 21

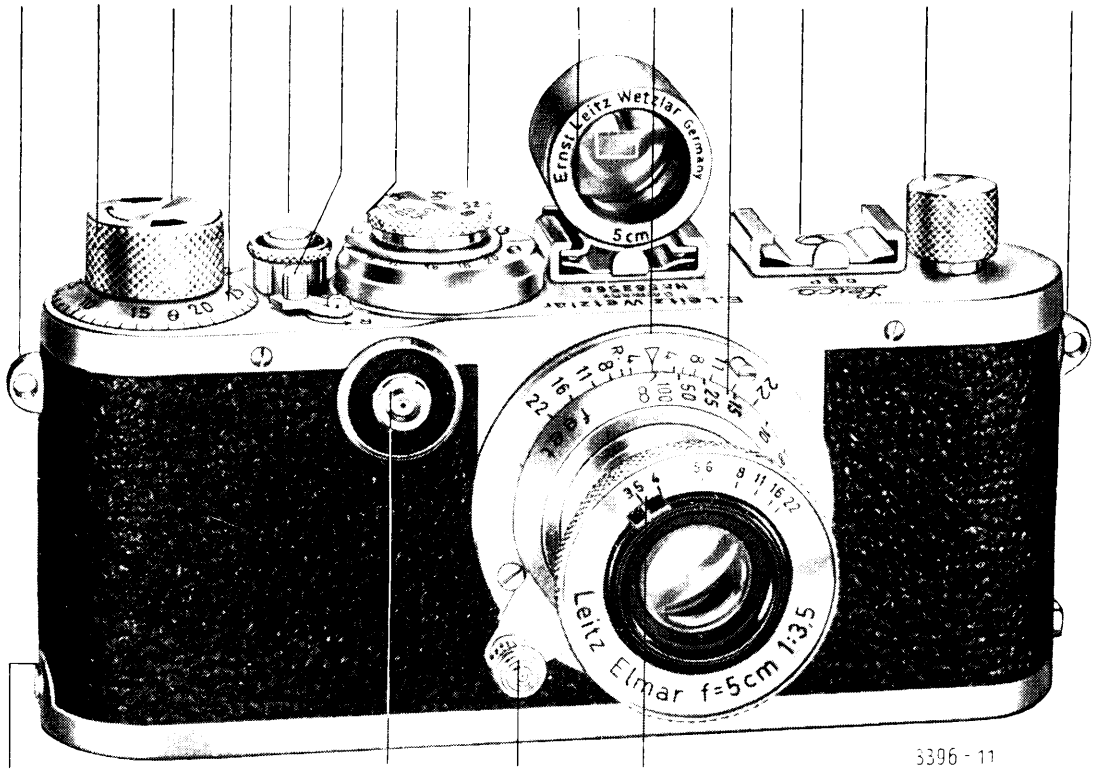

5396-11

22

19

8

7

LEICA III f

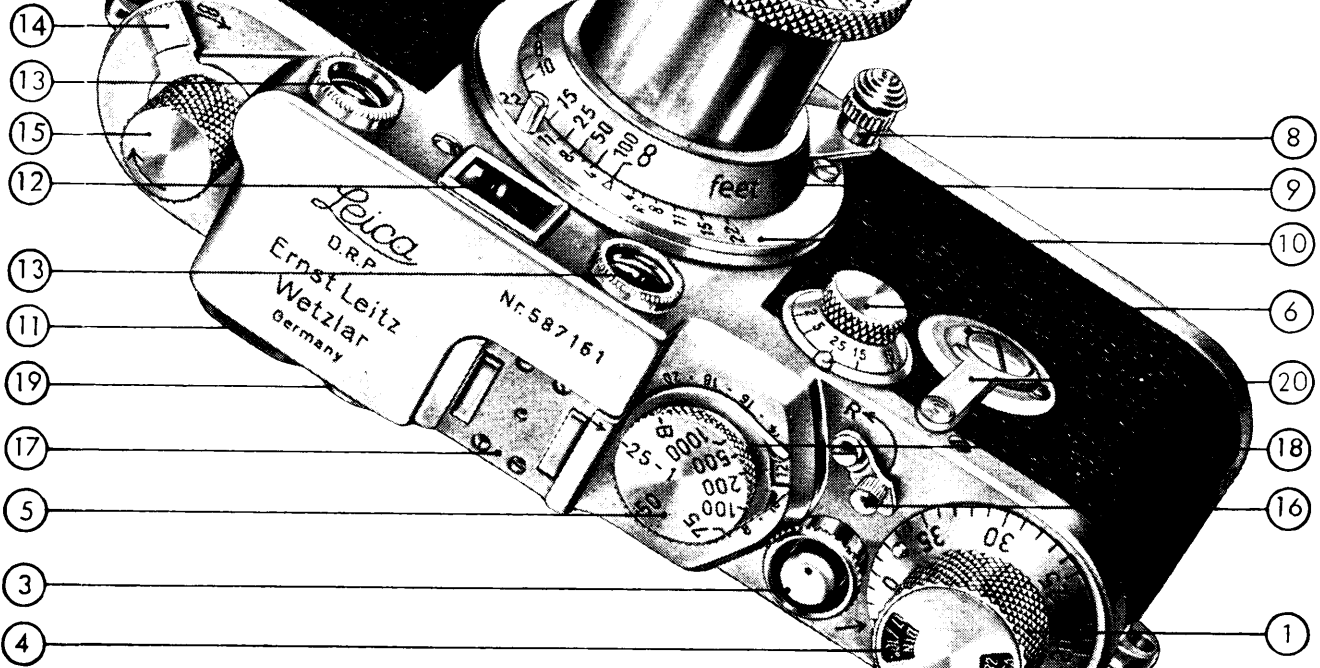

7

8

9

10

6

20

18

16

1

2

3412 e

These two pages indicate the various parts and controls of the LEICA. Compare the illustration on the left with your camera but do not yet operate any knob, button or lever.

- 1 Winding Knob**  
advances the film and winds shutter in one operation
- 2 Automatic exposure counter**
- 3 Shutter release**
- 4 Film type indicator**
- 5 Fast shutter-speed Dial**  
for speeds from  $1/25$  sec. to  $1/1000$  sec. and "Bulb"
- 6 Slow shutter-speed Dial** (only with III f Models)  
for speed from  $1/25$  sec. to 1 sec. and "Time"
- 7 Iris diaphragm adjustment**
- 8 Focusing lever with infinity catch**
- 9 Distance scale**
- 10 Depth of Field scale**
- 11 Twin eyepiece of viewfinder and rangefinder**
- 12 Viewfinder Window**
- 13 Rangefinder Window** (two)
- 14 Rangefinder eyepiece adjustment**
- 15 Rewinding knob**
- 16 Reversing Lever**  
R = Film RESERVE position  
A = Film ADVANCE position  
This lever must properly be set to A when loading the camera and when taking photographs.
- 17 Accessory shoe** for special viewfinder etc.
- 18 Adjustable flash contact scale**  
with red contact numbers
- 19 Flash plug socket** to connect flashgun cable
- 20 Lateral pin to hold lid**
- 21 Eyelet**
- 22 Self-timer**

You are now ready to practice with the unloaded camera. Continue until you are thoroughly familiar with the instructions given in the following pages and can even operate your LEICA in the dark.



There is no principle difference in handling the LEICA I f compared with the handling of the II f and III f models except the fact the I f LEICA has no automatic coupling of the range finder.

### Flash plug socket

The flash plug socket of the LEICA is at the front of the camera. The flash lead plug held in horizontal position and with the arrow engraved on it turning towards the lens is pushed into the flash socket and secured by a  $90^\circ$  turn to the right when the arrow will show upwards.

*Regarding the synchronizing of the camera and setting of the contact numbers please refer to pages 45 & 71*

### The rangefinder

is fitted to the accessory shoe (13).

### Focusing with the LEITZ range finder fitted to the camera

1. Select the framing of the image in the reflex finder.
2. Looking through the eyepiece of the range finder bring both images in coincidence by turning the milled scale. (Please also refer to page 35).
3. Read distance on the scale of the range finder and set lens accordingly.

### Setting of speed dials

After winding shutter, lift speed dial, turn it until the desired speed is opposite the arrow and allow the dial to drop into its catch.

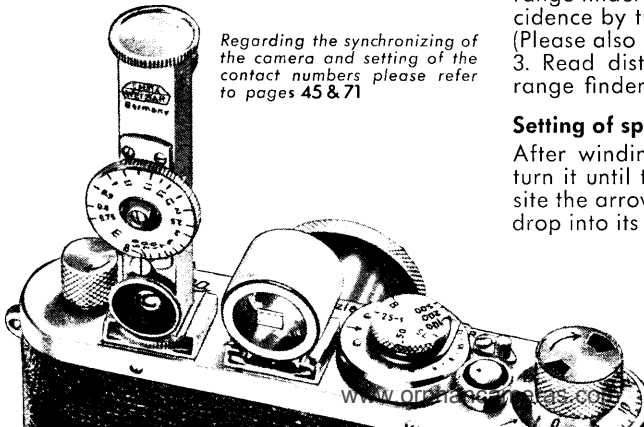

Set reversing lever  
to A (= advance).  
It must touch the stop pin.

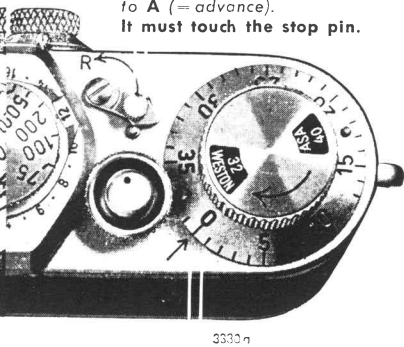

After loading with film  
set exposure counter to 0

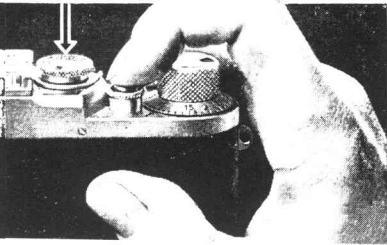

## 1 TURN WINDING KNOB

in the direction indicated by the arrow until it comes to a stop. This operation simultaneously winds the shutter and advances the film for the next exposure. Double exposures are thus prevented.

**Attention:** In the event of the reversing lever (6) not being shifted right to the stop A (Advance) the shutter winding and film advance mechanisms will remain blocked.

## 2 THE EXPOSURE COUNTER

automatically registers the number of exposures made, provided it was set to 0 when the new film was inserted. Note: the dial may be turned in an anti-clockwise direction, independently of the knob.

## 3 SHUTTER RELEASE

Press the button gently and firmly, avoiding any jerking movement. Use the index finger of the right hand when the camera is held horizontally, or the right thumb when a vertical picture is being made. A cable release may be screwed over the release button when required.

*Routine Practice:*

Set exposure counter to 0, wind and release shutter repeatedly, noting the action of the counter.

While the shutter is operating the main speed dial revolves. Avoid touching it when pressing the button.

## 4 THE FILM TYPE INDICATOR

When the winding knob is set to the type and speed of film used and a new adjustment made whenever the camera is loaded with different negative material. Film speeds are shown in ASA and Weston Exposure Index Numbers.

To set the film type indicator, lift the milled edge of the winding knob. For black-and-

white film turn it in the direction of the engraved arrow and let it drop into place at the correct setting. The lettering will then be in white on black. For colour film lift the milled edge and turn as far as required against the direction of the arrow. The letters ASA and Weston are then in white on red, which shows that the camera is loaded with colour film. The speed figure itself is always white on black.

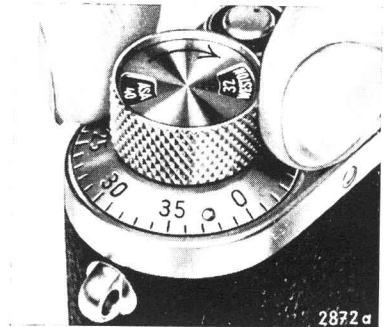

The winding knob is also available with a film type indicator for DIN and ASA speed values.

## SETTING THE SPEED DIALS



The old-fashioned invitation by the portrait photographer to "watch the birdie" has given place to the quiet click of the LEICA shutter.

Modern lenses and emulsions have reduced exposure times from minutes to fractions of a second.

The LEICA Model III f has two shutter speed dials: the main dial on the top and the slow-speed dial on the front of the camera.

After winding shutter, lift main speed dial, turn it until the desired speed is opposite the arrow and allow the dial to drop into its catch. At  $1/1000$  sec. the dial will not drop back quite so deeply.



## 5 FAST SHUTTER-SPEED DIAL

The engraved figures are the denominators of the fractions of a second they represent, e. g. 50 indicates  $1/50$  sec., 1000 signifies  $1/1000$  sec. and so on. The speed is set after winding the shutter by raising the dial and turning it until the desired figure falls opposite the arrow. It is then allowed to spring back into its seating. When set to "B" (bulb or brief time) the shutter remains open as long as pressure on the release button is maintained. When the shutter is re-wound the dial returns to the position occupied before release. The dial need not, therefore, be adjusted unless a different speed is required.

When exposures longer than  $1/25$  sec. are required the slow shutter-speed dial is brought into play as indicated overleaf.

### IMPORTANT RULE:

For exposures of  $1/25$  sec. and faster the shutter-speed dial on the top of the camera is set to the desired speed, but the slow-speed dial must be first set to red figure 25. To make exposures longer than  $1/25$  sec., first set the top dial to red mark 25-1. Thus, when working at  $1/25$  sec., both dials are set at red figures.

## 6 SLOW SHUTTER-SPEED DIAL

Before setting this dial the top dial of the LEICA must be set to the red index 25-1. **This is most important.** The figures on the slow-speed dial can be read from above and provide for exposures of  $1/25$ ,  $1/15$ ,  $1/10$ ,  $1/8$ ,  $1/6$ ,  $1/4$  and 1 sec., and "Time".

This range also covers speed intermediate between those marked; thus set half-way between  $1/2$  and 1 sec., the shutter yields an exposure of  $3/4$  sec. Intermediate speeds are not possible in the faster exposure range. When the slow-speed dial is set to "T", the shutter opens on being released and remains open until the slow-speed dial is turned back a little. A safety catch retains the slow-speed dial at the "25" position. This catch is released by the thumbnail, as shown at left, when slower speeds are required.

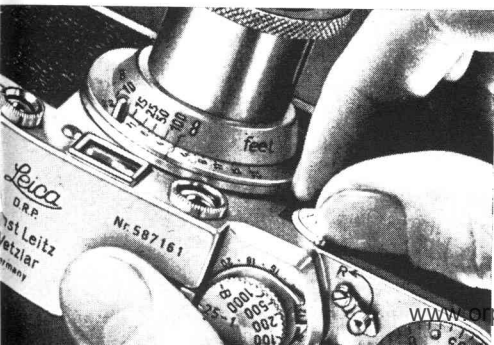
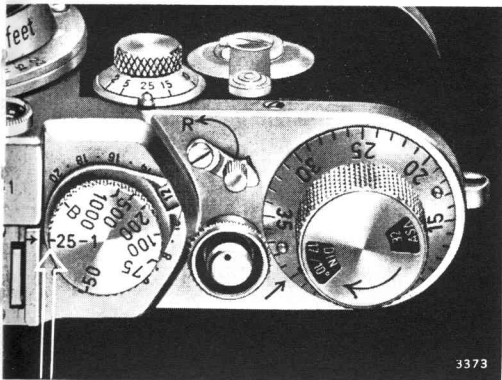

## SETTING SHUTTER SPEEDS — SUMMARY:

Short Instantaneous Exposures: from  $1/25$  to  $1/1000$  sec.

1. Set slow-speed dial to 25.
2. Wind shutter, lift fast-speed dial and turn to appropriate setting.

Slow Instantaneous Exposures:  $1/25$  sec. to 1 sec.

1. Wind shutter and set top speed dial to 25-1.
2. Set slow-speed dial.

Brief Time (Bulb) Exposures:

1. Set slow-speed dial to 25.
2. Wind shutter and set top dial to "B". The shutter will remain open so long as pressure is maintained on the release.

Time Exposures:

1. Wind shutter and set top speed dial to 25-1.
2. Set slow-speed dial to T. The shutter opens when pressure is applied to the release button and remains open until the slow-speed dial is turned slightly back.

*A bluish sheen characterises the "coated" or "bloomed" LEICA lenses. The coating, by reducing surface reflection, minimises loss of light and markedly improves the brilliance and contrast of the picture. The colour in itself is, however, no measure of the effectiveness of the coating.*

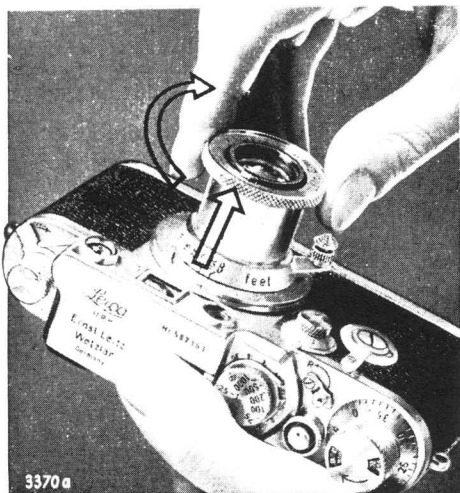

## THE BUILT-IN SELF-TIMER OF THE III f LEICA

Fig. 1 shows the lever in its normal position (pointing to the top).

Turning this lever downward as indicated by the arrow in fig. 2 the self-timer is wound up and arrests in its final position.

To release the self-timer the small knob at the side is pushed down when after approximately 10 seconds the shutter will be released automatically as seen in fig. 3.

The photographer will have time during the 10 seconds to get in position within the angle of the objective and by doing so being photographed himself.

The self-timer furthermore is used with advantage when a camera shake is to be prevented which otherwise can be a problem taking photos with longer exposure times and not using a tripod.

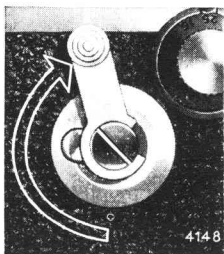
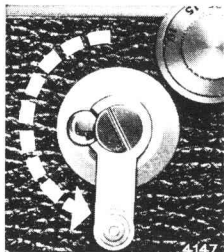
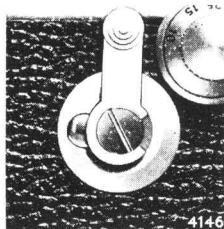

## THE STANDARD LENS OF THE LEICA

is the world-famous ELMAR having a maximum aperture of  $f/3.5$  and a focal length of 50 mm. Of the wide range of LEICA lenses it is the most useful general-purpose lens. It is highly corrected to ensure optimum definition. Its aperture is sufficiently wide for all but exceptional purposes.

The SUMMICRON  $f/2$  is of the same focal length but passes three times as much light as the ELMAR at full aperture. As is to be expected it is larger and heavier than the standard lens. It is intended for the experienced LEICA photographer for use under difficult lighting conditions.

Both ELMAR and SUMMICRON are fitted with collapsible mounts, the barrel sliding into the camera body when not in use. The lens is drawn out and locked in position by a slight clockwise turn, and returned to its collapsed position by reversing the movements.

**Routine Practice:** 1. Drawn out! Lock  
2. Unlock! Push back!



## CHANGING LENSES

All LEICA lenses are interchangeable and will fit any LEICA camera (except very early models). To change a lens hold the camera horizontally, lens pointing upwards, in the left hand, and with the right hand grasp the lens close to the camera body and unscrew it by turning anti-clockwise.

To fit the alternative lens, hold the camera as described and present the lens to the flange in such a way that, in the case of 35 or 50 mm lenses, the focusing

lever (8) is directly in front of the viewfinder window (12). Engage the threads by a slight anti-clockwise turn and screw home, turning the lens mount in a clockwise direction. The lens tube should be drawn forward and locked before the lens is fitted to the camera.

*When the lens is detached the shutter is visible. It is made of a special rubberised cloth, unaffected by temperature, while its flexibility ensures smooth running. Below the upper rim of the flange opening the lever will be seen which couples the focusing adjustment and the rangefinder. It is actuated by a helix on the lens barrel.*

**Rule: Do not change lenses in direct light. Turn away from the sun and work in the shadow of the body. When carrying extra lenses, fit a dust cover to protect the precision coupling mount. Also put a lens cap over the front component.**

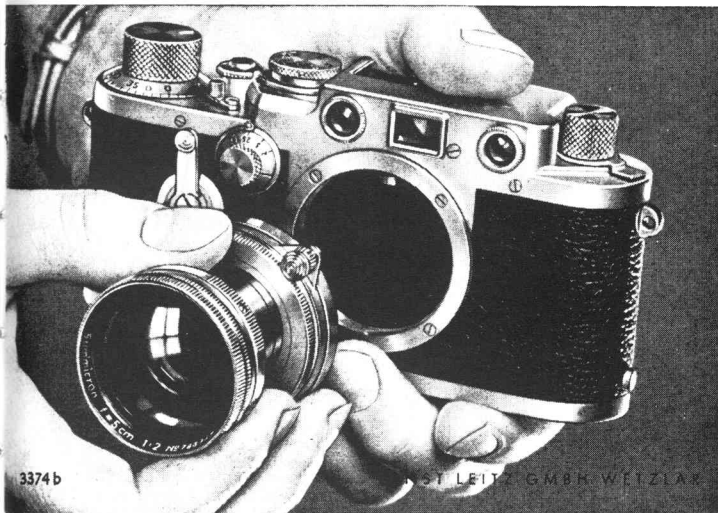

## 7 IRIS DIAPHRAGM ADJUSTMENT

The human eye is able to adapt itself to varying intensities of light by dilation or contraction of the pupil. The lower the light intensity the wider the pupil becomes and vice versa. The "pupil" of the photographic lens is enlarged or reduced by means of an iris diaphragm. The light-passing value of a lens is governed by the ratio of its focal length to the diameter of the "pupil", and is usually referred to as the "aperture" or "stop".

The numerical value of the stop is stated either as a ratio, thus 1 : 3.5 or commonly f/3.5. A lens of this value has a focal length three and a half times as large as the diameter of the pupil. Theoretically, all lenses having the same f-number pass the same amount of light for the purpose of exposure.

It is customary to graduate the aperture scale on photographic lenses so that the values vary in a 2 : 1 ratio. Thus, stopping down one division demands a doubling of exposure time, other conditions being equal.

The following table shows the relation between aperture value and exposure time:

exposure time:	0.5	1	2	(3)	4	8	16	32	64	128	
Relative											
lens aperture	1.4	1.5	2	2.8	(3.5)	4	5.6	8	11	16	22

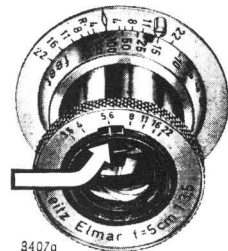

LEICA lenses ELMAR 50 mm. have the aperture scale engraved on the front of the lens mount. The iris is opened and closed by adjustment of a small lever engraved with an index line. On all other LEICA lenses the diaphragm is controlled by means of a milled ring.



## LENS APERTURE and EXPOSURE TIME

Example:

Assuming an exposure time of  $\frac{1}{100}$  sec. is correct for a diaphragm setting of  $f/5.6$ , the exposure time must be doubled, i. e. increased to  $\frac{1}{50}$  sec., if the diaphragm is stopped down to  $f/8$ , other conditions being equal. On the other hand, if the stop were opened up to  $f/4$ , only half of the exposure at  $f/5.6$  would be needed, viz.  $\frac{1}{200}$  sec. Slight differences in the exposure times used, especially somewhat longer times, are of no significance in practice and are covered by the latitude of modern films. For best results in photography, of course, correct exposure times should always be aimed at.

## 8 FOCUSING THE LENS

All LEICA lenses having a focusing lever are automatically locked at the infinity ( $\infty$ ) position. To release the lever for focusing on nearer subjects press the knob at the end of the lever.

*DON'T FORGET:*

*ELMAR 50 mm. and SUMMICRON 50 mm. lenses have collapsible mounts. The lens barrel must be drawn out and locked before focusing. (See page 30).*



## 9 DISTANCE SCALE

Normally, actual distances do not interest LEICA photographers as focusing is effected by the rangefinder. The distance scale, therefore, is of importance only when referring to the depth of field scale described on page 33.

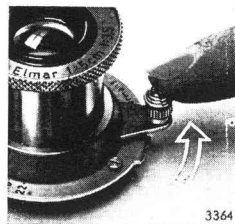

## GENERAL RULES FOR STOPPING DOWN

**1. Objects most sharply defined** are those at the distance at which the lens is focused. Therefore, always focus carefully on the centre of interest of the subject.

**2. Snapshots:** Stop down to  $f/5.6$  and focus on principal object. The depth of field will usually be sufficient.

**3. Long distance views without foreground interest:** Set lens to infinity and stop down to  $f/5.6$  or  $f/8$ .

**4. Landscapes with foreground:** Stop down so that the depth of field scale indicates a range extending from the foreground distance to infinity.

**5. Portraits:** Use full lens aperture and focus accurately on the eyes. The sitter should be sharply defined and the background subdued by being diffused.

### *The Second Index Line*

*marked R on distance scale is used for infra-red-photography. First focus accurately on the object in the usual way, then adjust the lens mount until index line R registers with the distance indicated by the rangefinder setting. Exceptions: When working with wide-angle lenses, no special adjustment is required.*



2604

## 10 DEPTH OF FIELD SCALE

An object is most sharply defined in a photograph when it lies at the distance on which the lens is focused. Definition would gradually deteriorate if the object were moved nearer the camera until a point would be reached when definition would be quite unsatisfactory. Similarly, definition would deteriorate, although not so rapidly, if the object were moved away from the camera. The distance between the nearest plane and the furthest plane at which objects are sufficiently sharply defined is known as the "depth of field" (often erroneously called "depth of focus"). It varies with the distance focused upon and the aperture of the lens. The nearer the principal object and the larger the stop of the lens the shallower the depth of field and therefore the more critical must focusing be.

A scale on LEICA lens mounts enables the depth of field to be read at each aperture and each distance setting down to 3.5 feet. Objects at distances between those indicated on the scale will be sufficiently sharply defined.

*Example: With a standard focal length of 50 mm., when the distance scale is set at 25 feet and the lens aperture at f3.5, the depth of field extends from 20 feet to 40 feet. With the lens stopped down to f5.6 it will extend from 16 feet to about 60 feet. At f11 all objects beyond 12 feet will be in focus.*

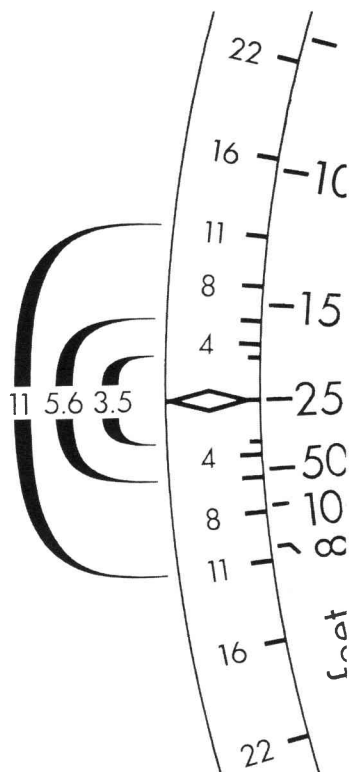

## VIEWFINDER and RANGEFINDER:

### 11 TWIN EYEPIECE

This carries the eyepieces of both viewfinder and rangefinder so that only a slight movement of the head is necessary when changing from one to the other.

Correction lenses can be fitted to the twin eyepiece, enabling users with defective eyesight to operate the LEICA without glasses. Such lenses are made to the user's optician's prescription.

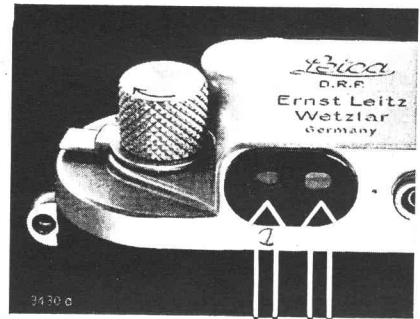

RANGEFINDER

VIEWFINDER

### 12 VIEWFINDER

The built-in viewfinder indicates the view embraced by the standard 50 mm. lenses. When lenses of other focal lengths are in use, the universal viewfinder, which fits into the accessory shoe (17), must be brought into use.

*Place the eye close to the twin eyepiece  
Care should be taken to look squarely  
through the centre of each eyepiece.*

The viewfinder of the LEICA If is detachable since this camera often serves special purposes, i. e. scientific photography, where other methods of observation are advantageous (micro-attachment, reflex housing etc.).

### 13 THE VIEWFINDER

of the LEICA If is of the reflecting type and can be used to good advantage on models If and III f.

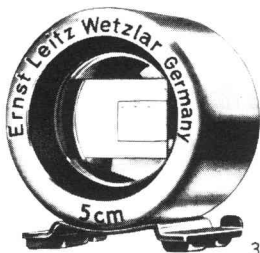
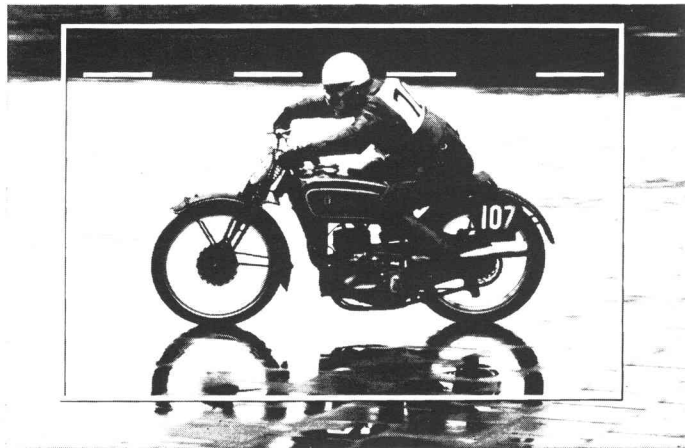

As the field covered by 50 mm. lenses is shown in its natural size this reflecting finder allows the use of both eyes, the brilliant field frame appearing in the observer's unimpaired natural field

of view without the risk of eyestrain.

A dotted line along the upper edge enables one to make adequate allowance for parallax in the case of close-ups (distances less than 10 feet).

## 14 COUPLED RANGEFINDER



In miniature photography accurate focusing is essential for perfect definition and sharp enlargements.

Former visual examination under

the black cloth is now replaced by the movement of a single finger.

The rangefinder coupled with the LEICA lens measures the distance and at the same time focuses the lens accurately on that distance.



Focusing is effected by means of the lens focusing lever (8). When the lens is set at "infinity", near objects appear to be "double" when viewed through the rangefinder. When the lever is operated so that the two images of an object coincide the lens is focused on that object. All interchangeable LEICA lenses up to 13.5 cm. focal length are automatically coupled with the rangefinder when screwed into the camera body.

Only LEICA If differs in that it has an attachable rangefinder without provision for coupling lenses (A conversion into models II f or III f is possible).

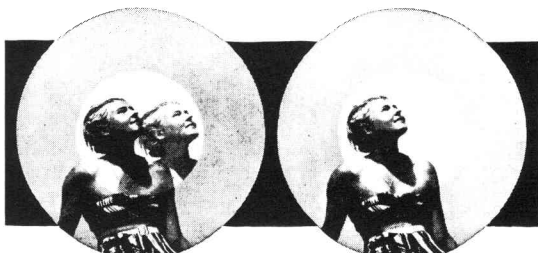

Out of focus

Correct focus

### How the coupled

#### Rangefinder works:

As the lens is focused, the backward and forward movement is communicated by a lever to the rangefinder, the precision of which resembles that of a high-grade microscope.

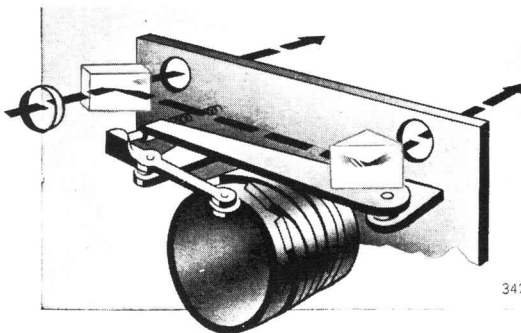

342

## 15 ADJUSTMENT OF RANGEFINDER TELESCOPE

The accuracy of the LEICA rangefinder is augmented by a built-in telescope having a magnification of 1.5. By means of the small lever (14) it may be focused on distant objects. It will also compensate for slight eyesight defects (between  $-2$  and  $+1.5$  dioptres).

To demonstrate the operation of the rangefinder: Sight, through the rangefinder, an object about 12 to 15 feet away, the lens being set to "infinity". Cover the left hand rangefinder window with the middle finger of the left hand. Look centrally into the rangefinder eyepiece. The object will be seen in a small circular field. Adjust lever (14) until the greatest possible sharpness is obtained. When the finger is removed from the window a double image of the

object will be seen in a larger circular field. Adjust the lens by lever (8) until the two images coincide. The lens is then accurately focused on the selected object. Unless the small field appears exactly in the centre of the larger, the line of sight is sideways and incorrect. Bearing this in mind will quickly enable the LEICA user to focus rapidly and accurately.

When working at short distances it is advisable to focus the lens by scale on the appropriate distance and correct slight difference by approaching or receding from the subject until the rangefinder images merge.

To enhance the colour differentiation of the rangefinder images a small orange filter in mount can be fitted to the left window (13).